



INSTRUMENTS

GX-2012
Operator's Manual

Part Number: 71-0239RK

Revision: 0

Released: 2/27/12

www.rkiinstruments.com

WARNING

Read and understand this instruction manual before operating instrument. Improper use of the gas monitor could result in bodily harm or death.

Periodic calibration and maintenance of the gas monitor is essential for proper operation and correct readings. Please calibrate and maintain this instrument regularly! Frequency of calibration depends upon the type of use you have and the sensor types. Typical calibration frequencies for most applications are between 1 and 3 months, but can be required more often or less often based on your usage.

Warranty

RKI Instruments, Inc. warrants the GX-2012 sold by us to be free from defects in materials, workmanship, and performance for a period of two years from the date of shipment from RKI Instruments, Inc. This includes the instrument and the original sensors. Replacement parts are warranted for 1 year from the date of their shipment from RKI Instruments, Inc. except for replacement sensors which are warranted for 2 years. Any parts found defective within their warranty period will be repaired or replaced, at our option, free of charge. This warranty does not apply to those items which by their nature are subject to deterioration or consumption in normal service, and which must be cleaned, repaired, or replaced on a routine basis. Examples of such items are:

Absorbent cartridges

Filter elements, disks, or sheets

Pump diaphragms and valves

Warranty is voided by abuse including mechanical damage, alteration, rough handling, or repair procedures not in accordance with the instruction manual. This warranty indicates the full extent of our liability, and we are not responsible for removal or replacement costs, local repair costs, transportation costs, or contingent expenses incurred without our prior approval.

THIS WARRANTY IS EXPRESSLY IN LIEU OF ANY AND ALL OTHER WARRANTIES AND REPRESENTATIONS, EXPRESSED OR IMPLIED, AND ALL OTHER OBLIGATIONS OR LIABILITIES ON THE PART OF RKI INSTRUMENTS, INC. INCLUDING BUT NOT LIMITED TO THE WARRANTY OF MERCHANTABILITY OR FITNESS FOR A PARTICULAR PURPOSE. IN NO EVENT SHALL RKI INSTRUMENTS, INC. BE LIABLE FOR INDIRECT, INCIDENTAL, OR CONSEQUENTIAL LOSS OR DAMAGE OF ANY KIND CONNECTED WITH THE USE OF ITS PRODUCTS OR FAILURE OF ITS PRODUCTS TO FUNCTION OR OPERATE PROPERLY.

This warranty covers instruments and parts sold to users only by authorized distributors, dealers, and representatives as appointed by RKI Instruments, Inc.

We do not assume indemnification for any accident or damage caused by the operation of this gas monitor and our warranty is limited to replacement of parts or our complete goods.

Table of Contents

Chapter 1: Introduction	1
Overview	1
About the GX-2012	1
Specifications	3
About This Manual	4
Chapter 2: Description	5
Overview	5
Instrument Description	5
<i>Case</i>	6
<i>Sensors</i>	6
<i>LCD</i>	8
<i>Control Buttons</i>	9
<i>Printed Circuit Boards</i>	9
<i>Alarm LED Arrays</i>	9
<i>Infrared Communications Port</i>	9
<i>Buzzer</i>	10
<i>Vibrator</i>	10
<i>Batteries</i>	10
<i>Pump</i>	11
<i>Flow Chamber</i>	11
<i>Sensors and Filters</i>	11
<i>Inlet Filter Holder</i>	11
Standard Accessories	12
<i>Tapered Rubber Nozzle</i>	12
<i>Belt Clip</i>	12
<i>Wrist Strap</i>	12
<i>Sample Hose & 10 Inch Probe</i>	12
Optional Accessories	13
<i>Charging Stations</i>	13
<i>Optional Probes</i>	16
<i>Purge Tee Fitting</i>	18
<i>External Dilution Fitting</i>	18

Chapter 3: Using the GX-2012 in Normal Mode	19
Overview	19
Start Up, Normal Mode	19
<i>Turning On the GX-2012, Normal Mode Only</i>	19
<i>Turning On the GX-2012 in Normal With All Modes Active</i>	25
<i>Performing a Fresh Air Adjustment, Normal Mode</i>	27
<i>Turning Off the GX-2012, Normal Mode</i>	27
Measuring Mode, Normal Operation	28
<i>Monitoring an Area</i>	28
<i>Using Optional Probes and Fittings</i>	29
<i>Combustible Gas Detection</i>	31
<i>Snap Log Mode</i>	32
Measuring Mode, Alarms	35
<i>Alarm Indications</i>	35
<i>Resetting and Silencing Alarms</i>	37
<i>Responding to Alarms</i>	38
Inert Mode	41
<i>Alarms</i>	41
<i>Start Up and Operation</i>	41
Display Mode	42
<i>HC Range Screen</i>	43
<i>Peak Screen</i>	43
<i>STEL Screen</i>	44
<i>TWA Screen</i>	44
<i>Alarm Points Screen</i>	45
<i>Operation Time Screen</i>	46
<i>Date/Time Screen</i>	47
<i>Remaining Log Time Screen</i>	50
<i>Clear Data Logger Screens</i>	48
<i>Pump Off Screen</i>	49
<i>User ID Screen</i>	50
<i>Station ID Screen</i>	51
<i>Snap Logging Screen</i>	52
<i>Peak Bar Select Screen</i>	54
Datalogging	55
SDM-2012	55
Calibration Mode	56
<i>Calibration/Bump Test Supplies and Equipment</i>	56

<i>Preparing for Calibration or Bump Test</i>	57
<i>Calibrating the GX-2012</i>	57
<i>Bump Testing the GX-2012</i>	64
Chapter 4: Using the GX-2012 in Bar Hole Mode	71
Overview	71
Start Up, Bar Hole Mode	71
<i>Turning On the GX-2012, Bar Hole Mode</i>	71
<i>Performing a Fresh Air Adjustment, Bar Hole Mode</i>	77
<i>Bar Hole Testing</i>	78
<i>Performing a Bar Hole Test</i>	78
<i>Turning Off the GX-2012, Bar Hole Mode</i>	81
Chapter 5: Maintenance Mode	82
Overview	82
Tips for Using Maintenance Mode	83
Using Maintenance Mode	83
<i>Updating the Date and Time Settings</i>	85
<i>Performing a Fresh Air Adjustment</i>	85
<i>Calibrating Using Auto Calibration</i>	86
<i>Calibration Using Single Calibration</i>	90
<i>Performing a Bump Test</i>	92
<i>Turning the Lunch Break Setting On or Off</i>	97
<i>Updating the Alarm Latching Settings</i>	98
<i>Updating the Alarm Silence Settings</i>	99
<i>Updating the Data Logging Interval</i>	100
<i>Updating the Alarm Point Settings</i>	101
<i>Turning the Clear Data Logger Screen On or Off</i>	105
<i>Turning the Bump Test Function On or Off</i>	106
<i>Turning the Pump Off Screen On or Off</i>	107
<i>Updating the Bump Test Parameters</i>	108
<i>Updating the Confirmation Beep Setting</i>	110
<i>Updating the DataLog Overwrite Setting</i>	110
<i>Updating the Calibration Interval</i>	111
<i>Updating the Calibration Reminder Setting</i>	111
<i>Updating the Calibration Expired Action Setting</i>	112
<i>Updating the Calibration Check Setting</i>	112
<i>Updating the Bump Test Interval</i>	113

<i>Updating the Bump Test Reminder Setting</i>	114
<i>Updating the Bump Test Expired Action Setting</i>	114
<i>Updating the Bump Test Check Setting</i>	115
<i>Turning the ID Display Function On or Off</i>	116
<i>Updating the LCD Backlight Time Setting</i>	116
<i>Updating the Autozero Function</i>	117
<i>Updating the Demand Zero Function</i>	117
<i>Updating the Leak Check/Bar Hole Mode Setting</i>	118
<i>Updating the Bar Hole Sampling Time</i>	119
<i>Viewing the ROM/SUM Information</i>	119
<i>Turning the Password Function On or Off</i>	120
<i>Performing a Low Flow Setpoint Adjustment</i>	121
<i>Exiting Maintenance Mode</i>	122

Chapter 6: Maintenance 123

Overview	123
Troubleshooting	123
Replacing or Recharging the Batteries	126
<i>Replacing Alkaline Batteries</i>	126
<i>Replacing the Lithium Ion Battery Pack</i>	127
<i>Recharging the Lithium Ion Battery Pack in the Instrument</i>	128
<i>Recharging the Lithium Ion Battery Pack Out of the Instrument</i>	130
Replacing the LEL and CO Filters	133
Replacing a Sensor	135
Replacing the Hydrophobic Disk Filter, Cotton Filter, and Wire Mesh Disk	137
Parts List	138

**Appendix A: Calibrating and Bump Testing
with a Sample Bag 141**

Overview	141
Calibration/Bump Test Supplies & Equipment	141
Preparing for Calibration or Bump Testing	142
Calibrating the GX-2012	144
<i>Calibrating with the Auto Calibration Method</i>	145
<i>Calibrating with the Single Calibration Method</i>	149
Bump Testing	151
Parts List	157

WARNING: Understand manual before operating. Substitution of components may impair intrinsic safety. To prevent ignition of a hazardous atmosphere, batteries must only be changed or charged in an area known to be nonhazardous. Not tested in oxygen enriched atmospheres (above 21%).

Chapter 1: Introduction

Overview

This chapter briefly describes the GX-2012. This chapter also describes the *GX-2012 Operator's Manual* (this document). Table 1 at the end of this chapter lists the specifications for the GX-2012.

About the GX-2012

Using an advanced detection system consisting of up to five gas sensors, the GX-2012 sample draw gas monitor detects the presence of combustible gas, oxygen (O₂), carbon monoxide (CO), and hydrogen sulfide (H₂S) simultaneously. The GX-2012's compact size and easy-to-use design makes it ideally suited for a wide range of applications, including sewage treatment plants, utility manholes, tunnels, hazardous waste sites, power stations, petrochemical refineries, mines, paper mills, drilling rigs, and fire fighting stations. The

GX-2012 offers a full range of features, including:

- Simultaneous four-gas monitoring of combustible gases, O₂, CO, and H₂S (in Normal Mode)
- Choice of two operating modes: Normal Mode for typical confined space or area monitoring and Bar Hole Mode for checking of bar holes when searching for underground gas leaks
- Sample-drawing pump with up to 50-foot range
- Liquid crystal display (LCD) for complete and understandable information at a glance
- Distinctive audible/vibrating alarms for dangerous gas conditions and audible alarms for unit malfunction
- Microprocessor control for reliability, ease of use, and advanced capabilities
- Alarm trend data (when used in Normal Mode)
- Data logging functions (when used in Normal Mode)
- STEL/TWA (when used in Normal Mode) and over range alarm display
- Peak hold and average readouts (when used in Normal Mode)
- Built-in time function

- RF shielded high impact plastic case
- CSA classification pending for Class I, Division I, Groups A, B, C, and D hazardous atmospheres

WARNING: The GX-2012 detects oxygen deficiency, elevated levels of oxygen, combustible gases, carbon monoxide, and hydrogen sulfide, all of which can be dangerous or life threatening. When using the GX-2012, you must follow the instructions and warnings in this manual to assure proper and safe operation of the unit and to minimize the risk of personal injury. Be sure to maintain and periodically calibrate the GX-2012 as described in this manual.

NOTE: ONLY THE COMBUSTIBLE GAS DETECTION PORTION OF THIS INSTRUMENT HAS BEEN ASSESSED FOR PERFORMANCE.

Specifications

Table 1: GX-2012 Specifications

Target Gas	%LEL Combustible Gas (Methane Calibration Standard)	% Volume Combustible Gas (Methane Calibration Standard)	Oxygen (O ₂)	Hydrogen Sulfide (H ₂ S)	Carbon Monoxide (CO)
Range (Increment)	0-100% LEL (1% LEL)	0 - 100% vol (1% vol)	0-40.0% vol (0.1 vol%)	0-100 ppm (0.5 ppm)	0-500 ppm (1 ppm)
Sampling Method	Sample Draw				
Response Time	T90 Within 30 Seconds				
Accuracy	± 5% of reading or ± 2% LEL (whichever is greater)	± 5% of reading or ± 2% full scale (whichever is greater)	± 0.5% O ₂	± 5% of reading or ± 2 ppm H ₂ S (whichever is greater)	± 5% of reading or ± 5 ppm CO (whichever is greater)
Display	Digital LCD Display				
Gas Alarms (Factory Settings)	<p><u>Alarm 1</u> 10% LEL</p> <p><u>Alarm 2</u> 50% LEL</p>	None	<p><u>Alarm 1</u> 19.5 vol% (Decreasing)</p> <p><u>Alarm 2</u> 23.5 vol% (Increasing)</p>	<p><u>Alarm 1</u> 5 ppm</p> <p><u>Alarm 2</u> 30 ppm</p> <p><u>TWA</u> 10 ppm</p> <p><u>STEL</u> 15 ppm</p>	<p><u>Alarm 1</u> 25 ppm</p> <p><u>Alarm 2</u> 50 ppm</p> <p><u>TWA</u> 25 ppm</p> <p><u>STEL</u> 200 ppm</p>
Operating Temperature & Humidity	-20°C to 50°C/Below 85% RH (Without Condensation)				
Safety/Regulatory	<p style="text-align: center;">  C US pending CSA classified, "C/US", as Intrinsically Safe. Exia. Class I, Groups A, B, C, & D. Temperature Code T3C. </p>				
Power Supply	<ul style="list-style-type: none"> • Three AA size alkaline batteries standard • Lithium Ion Battery Pack (3.7 VDC Nominal) optional, Direct Charging 				

Continuous Operating Hours @ 25 °C	<ul style="list-style-type: none"> Alkaline Batteries: 15 Hours (Non Alarm Operation, Fully Charged) Lithium Ion Battery Pack: 10 Hours (Non alarm Operation, Fully Charged)
Case	High-impact Plastic with protective rubber layer, RF Shielded, Dust and Weather Proof
Standard Accessories	<ul style="list-style-type: none"> 10 foot hose 10 inch probe Flexible 4 inch tapered rubber nozzle
Optional Accessories	<ul style="list-style-type: none"> Rechargeable Lithium-Ion Battery Pack 115 VAC Charging Station 12 VDC Charging Station Data Logger Management Program IrDA/USB Cable for Downloading Data to a Computer With Data Logger Management Program Software (not needed if computer has an infrared port) SDM-2012 Automatic Calibration Station & Software Various Probes (see "Parts List" on page 157)
Dimensions and Weight	<p>Approximately 171(H) x 65(W) x 39(D) mm (5.6"H x 2.5"W x 1.5"D)</p> <p>Approximately 310 g (11 oz.)</p>

About this Manual

The *GX-2012 Operator's Manual* uses the following conventions for notes, cautions, and warnings.

NOTE: Describes additional or critical information.

CAUTION: *Describes potential damage to equipment.*

WARNING: *Describes potential danger that can result in injury or death.*

Chapter 2: Description

Overview

This chapter describes the GX-2012 instrument and accessories.

Instrument Description

The instrument includes the case, sensors, LCD, control buttons, printed circuit boards, alarm LED's, infrared communication port, buzzer, vibrator, batteries, pump, flow chamber, and inlet filter holder.

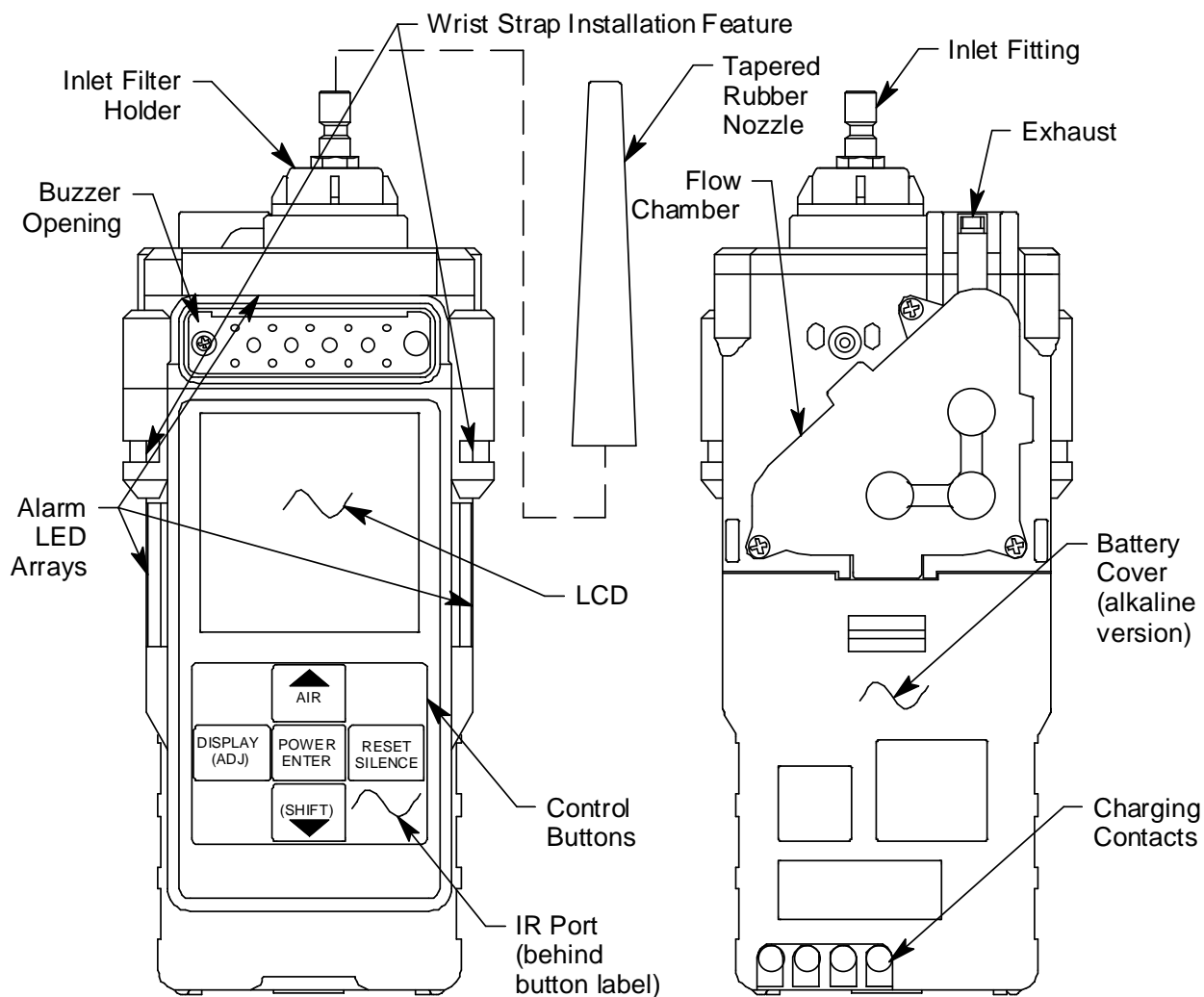

Figure 1: Components of the GX-2012, Front & Back

Rechargeable Version

Alkaline Version

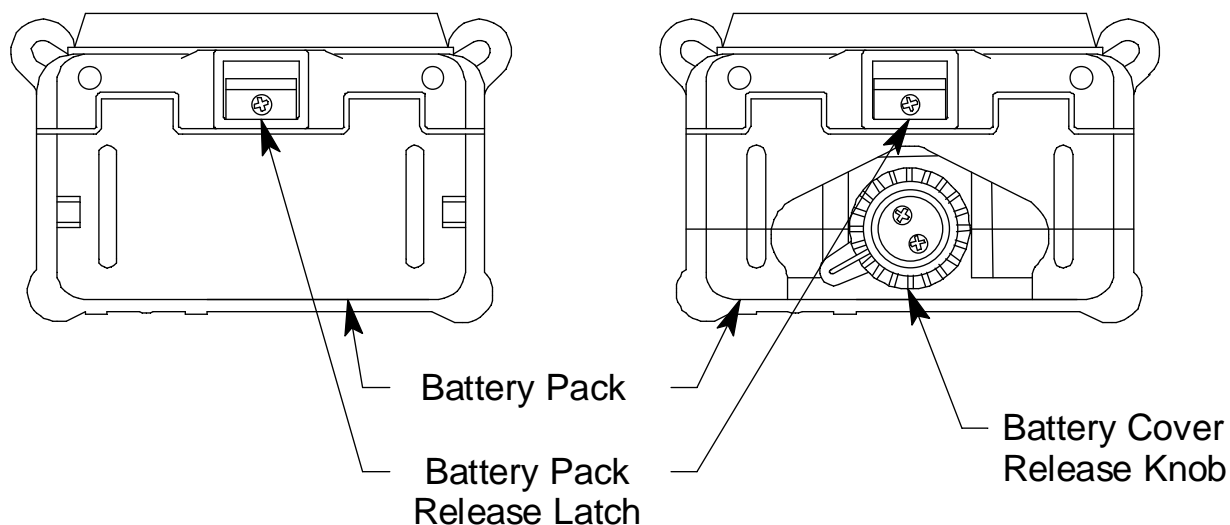

Figure 2: Components of the GX-2012, Bottom

Case

The Model GX-2012's sturdy, high-impact plastic case is radio frequency (RF) resistant and is suitable for use in many environmental conditions, indoors and out. The case is dust proof and weather resistant. A rubber layer on the outside of the case protects it from scratches and impact damage.

A clear plastic window through which the LCD can be viewed is located on the front of the case. Four brass charging contacts that are used when the GX-2012 is placed in the charging station are on the back of the case. Both the rechargeable and alkaline versions include a removable battery pack. The battery pack release latch is on the bottom. The alkaline battery version also includes a battery cover release knob. The battery pack and flow chamber are located on the back of the GX-2012. The inlet filter holder is located on the top of the GX-2012 case.

Sensors

The GX-2012 uses up to five sensors to monitor combustible gas, oxygen (O₂), carbon monoxide (CO), and hydrogen sulfide (H₂S) simultaneously. The sensors are located inside the GX-2012 and are held in their sockets by the flow chamber. The sensors use different detection principles, as described below.

Combustible Gas Sensors

% LEL Sensor (NC-6264A)

The % LEL sensor detects combustible gas in the % LEL range. It uses a catalytic element for detection. The reaction of gas with oxygen on the catalyst causes a change in the resistance of the element which affects the current flowing through it. The current is amplified by the GX-2012's circuitry, converted to a measurement of combustible gas concentration, and displayed on the LCD.

%Volume Sensor (TE-7561)

The % volume sensor detects combustible gas in the % volume range. It uses a thermal conductivity (TC) element for detection. The presence of combustible gas cools the element causing a change in the resistance of the element which affects the current flowing through it. The current is amplified by the GX-2012's circuitry, converted to a measurement of combustible gas concentration, and displayed on the LCD.

Oxygen Sensor

The O₂ sensor is a galvanic type of sensor. A membrane covers the cell and allows gas to diffuse into the cell at a rate proportional to the partial pressure of oxygen. The oxygen reacts in the cell and produces a voltage proportional to the concentration of oxygen. The voltage is measured by the GX-2012's circuitry, converted to a measurement of gas concentration, and displayed on the LCD.

CO and H₂S Sensors

The CO and H₂S sensors are electrochemical cells that consist of two precious metal electrodes in a dilute acid electrolyte. A gas permeable membrane covers the sensor face and allows gas to diffuse into the electrolyte. The gas reacts in the sensor and produces a current proportional to the concentration of the target gas. The current is amplified by the GX-2012's circuitry, converted to a measurement of gas concentration, and displayed on the LCD.

Dummy Sensors

Any unit that has less than 5 sensors will have a dummy sensor installed in one or more sensor positions. Dummy sensors are factory installed. The flat top of the dummy sensor should face up and the bottom hollow side should face down. The unit shown below is a standard 4-sensor unit for LEL/O₂/H₂S/CO and has a dummy sensor installed in the % volume combustible sensor position.

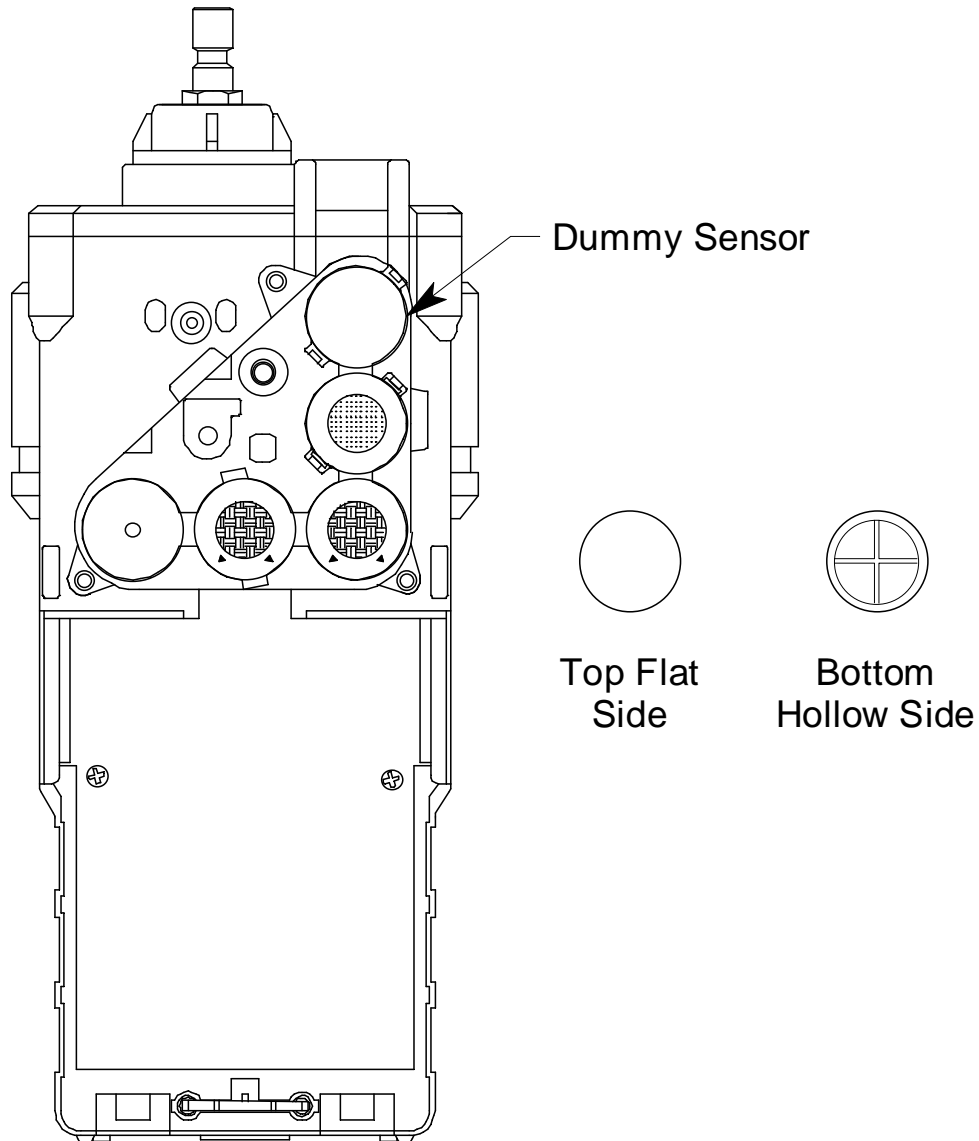

Figure 3: Dummy Sensor

LCD

A digital LCD (liquid crystal display) is visible through a clear plastic window on the front of the case. The LCD display simultaneously shows the gas reading for all installed sensors. The display also shows information for each of the GX-2012's program modes.

Control Buttons

Five control buttons are located below the LCD. They are arranged around a central button, the POWER ENTER button. The DISPLAY (ADJ) button is on the left, the RESET SILENCE button on the right, the AIR▲ button on the top, and the (SHIFT)▼ is on the bottom.

Table 2: GX-2012 Control Button Functions

Button	Function(s)
POWER ENTER	<ul style="list-style-type: none">• turns the GX-2012 on and off.• used during setup and calibration.
RESET SILENCE	silences and resets audible alarm if the GX-2012 is programmed for latching alarms and the alarm silence option is on ¹
DISPLAY (ADJ)	<ul style="list-style-type: none">• activates Display Mode• enters instructions into the GX-2012's microprocessor
AIR▲	<ul style="list-style-type: none">• activates the demand-zero function (automatically adjusts the GX-2012 in fresh-air conditions)• scrolls through the display and settings modes
(SHIFT)▼	<ul style="list-style-type: none">• scrolls through the display and settings modes• enters instructions into the GX-2012's microprocessor

¹ The GX-2012's alarms are user-adjustable. See "Chapter 5: Maintenance Mode" on page 82.

Printed Circuit Boards

The GX-2012 printed circuit boards analyze, record, control, store, and display the information collected. The circuit boards are located inside the case. They are not user serviceable.

Alarm LED Arrays

Three red alarm LED (light emitting diode) arrays are visible through frosted plastic lenses in the case. One is on the top front, one on the left side, and one on the right side. The alarm LED arrays alert you to gas, low battery, and failure alarms.

Infrared Communications Port

An infrared (IR) communications port is located just below the RESET SILENCE button. The signal goes through the control button material. The data transmitted through the port is in standard IrDA protocol. A computer's infrared port or an IrDA/USB cable connected to a computer's USB port can be used to download data saved by the GX-2012 to a computer using the GX-2012 Data Logger Management Program. See the GX-2012 Data Logger Management Program operator's manual for data logging and downloading instructions.

Buzzer

One solid-state electronic buzzer is located inside the case. Holes on the top front of the case allow the sound to exit the case. The buzzer sounds for gas alarms, malfunctions, low battery voltage, and as an indicator during use of the GX-2012's many display and adjustment options.

Vibrator

A vibrating motor inside the GX-2012 case vibrates for gas alarms, unit malfunctions, and as an indicator during normal use of the various modes of the GX-2012.

Batteries

Three AA-size alkaline batteries (standard) or an optional rechargeable lithium ion battery pack (3.7 VDC) power the GX-2012. Instrument run time is dependent upon battery type. At 25°C the alkaline batteries last up to 15 hours and the lithium ion battery pack lasts up to 10 hours. The battery icon in the upper right of the LCD shows remaining battery life.

When the GX-2012 detects a low battery voltage, a low battery warning is activated. When battery voltage is too low for normal operation, the GX-2012 sounds a dead battery alarm.

The alkaline batteries can be replaced by removing the battery cover on the back of the case. The lithium ion pack can be replaced by removing the entire battery pack. Push the battery pack latch on the bottom of the unit toward the front of the unit to release the pack.

The lithium ion battery pack can be recharged by placing the GX-2012 in its optional battery charging station or by placing the battery pack in the charging station.

NOTE: Use of batteries or battery chargers not specified by RKI Instruments, Inc. will void the CSA classification and may void the warranty. See "Replacing or Recharging the Batteries" on page 126.

WARNING: *To prevent ignition of a hazardous atmosphere, batteries must only be changed or charged in an area known to be nonhazardous.*

Pump

A diaphragm pump inside the GX-2012 draws the sample to the sensors. It can draw sample from as far as 50 feet from the GX-2012. The pump is not user serviceable.

CAUTION: Sample hose lengths of more than 50 feet are not recommended for the GX-2012 because of flow rate reduction.

Flow Chamber

The flow chamber is on the back of the GX-2012 and is held in place by three phillips screws. The flow chamber seals to the rubber sensor gasket which seals to the sensor faces inside the GX-2012 and routes flow from the pump to the sensors and to the exhaust port (also a part of the flow chamber).

Sensors and Filters

The sensors are located underneath the flow chamber and are only accessible if you remove the flow chamber and the sensor gasket.

An H₂S removal filter disk is placed into a recess in the sensor gasket over the %LEL sensor. This filter darkens as it absorbs H₂S and should be replaced when it is a dark brown color. Check the condition of this filter quarterly.

A charcoal filter is placed into a recess in the sensor gasket over the CO sensor. The charcoal filter is black, has a woven texture, and is impregnated with an H₂S absorbing material. The CO sensor will respond if exposed to H₂S and certain hydrocarbon gases. The charcoal filter disk scrubs these gases out of the sample to avoid false CO readings. If false or elevated CO readings are noticed, especially in the presence of H₂S, change the charcoal filter.

Inlet Filter Holder

The filter holder is a clear plastic dome shaped piece on the top of the case. A male quick connect fitting is located on the inlet filter holder. This is the GX-2012's inlet fitting. A cotton dust filter is inside the filter holder. The filter holder may be removed by turning it counterclockwise and pulling it away from the case. Two flat membrane disk hydrophobic filters, a wire mesh disk, and a rubber filter retaining gasket are held in place by the filter holder and are located in the bottom of the case chamber where the filter holder is installed.

Standard Accessories

The standard accessories include the tapered rubber nozzle, belt clip, sample hose, and 10 inch probe. An optional bar hole probe is also available and is described at the end of this section.

Tapered Rubber Nozzle

A cone shaped 4 inch long rubber nozzle is included with the GX-2012 as standard. It can be installed on the inlet fitting by pushing the larger end over it. The smaller end can be inserted through a hole in a wall or some other access to an enclosed area to sample the environment.

Belt Clip

A belt clip can be mounted to the back of the case using 3 phillips head screws. The belt clip allows the GX-2012 to be securely attached to a belt.

Wrist Strap

A wrist strap is included with the GX-2012 and can be attached to the right or left wrist strap installation feature.

Sample Hose & 10 Inch Probe

A 10 foot sample hose and a 10 inch probe are included as standard with the GX-2012. When desired, the rubber nozzle may be removed and the sample hose and 10 inch probe may be connected to the inlet fitting. Sample hose lengths are available from 10 feet to 50 feet (see “Parts List” on page 138). The quick connect end of the sample hose connects to the inlet fitting of the GX-2012 and the probe screws onto the end of the hose with the threaded fitting.

CAUTION: *Sample hose lengths of more than 50 feet are not recommended for the GX-2012 because of flow rate reduction.*

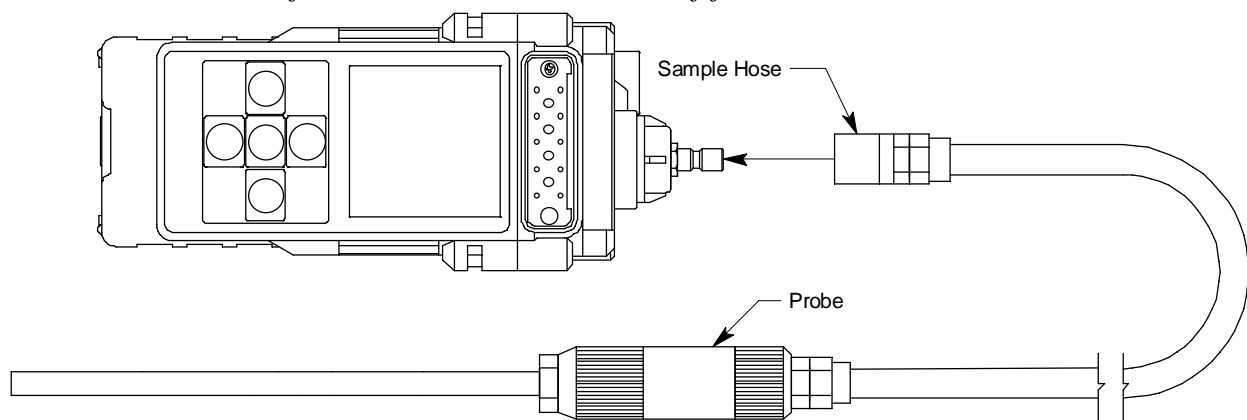

Figure 4: Sample Hose and Probe

Optional Accessories

Several optional accessories are available for the GX-2012. They include a rechargeable lithium ion battery pack, charging stations, various special probes, a purge tee fitting, and a dilution fitting. The most commonly used optional accessories are described below. Detailed instructions regarding the use of these and other available accessories are included in other parts of this manual. Data logging accessories are briefly described in “Data Logging” on page 55.

Rechargeable Lithium Ion Battery Pack

A rechargeable lithium ion battery pack is available for the GX-2012. A fully charged battery pack will power the GX-2012 for 10 hours. The batteries will last for a minimum of 500 charge cycles. See the “Parts List” on page 138 for ordering information.

Charging Stations

The GX-2012 lithium ion battery pack is charged with the GX-2012 charging station. Two battery charging stations are available for the GX-2012, the standard AC charging station, and a DC charging station with a vehicle plug adapter.

AC Powered Charging Station

The standard AC powered charging station consists of an instrument charging base and an AC adapter. The AC adapter plugs into a 115 VAC wall outlet and connects to the charging station with a jack on the end of a five foot DC output cable. The AC adapter will also work for 100 VAC or 220 VAC if an appropriate plug adapter is provided. The AC charging station is shown below in Figure 5.

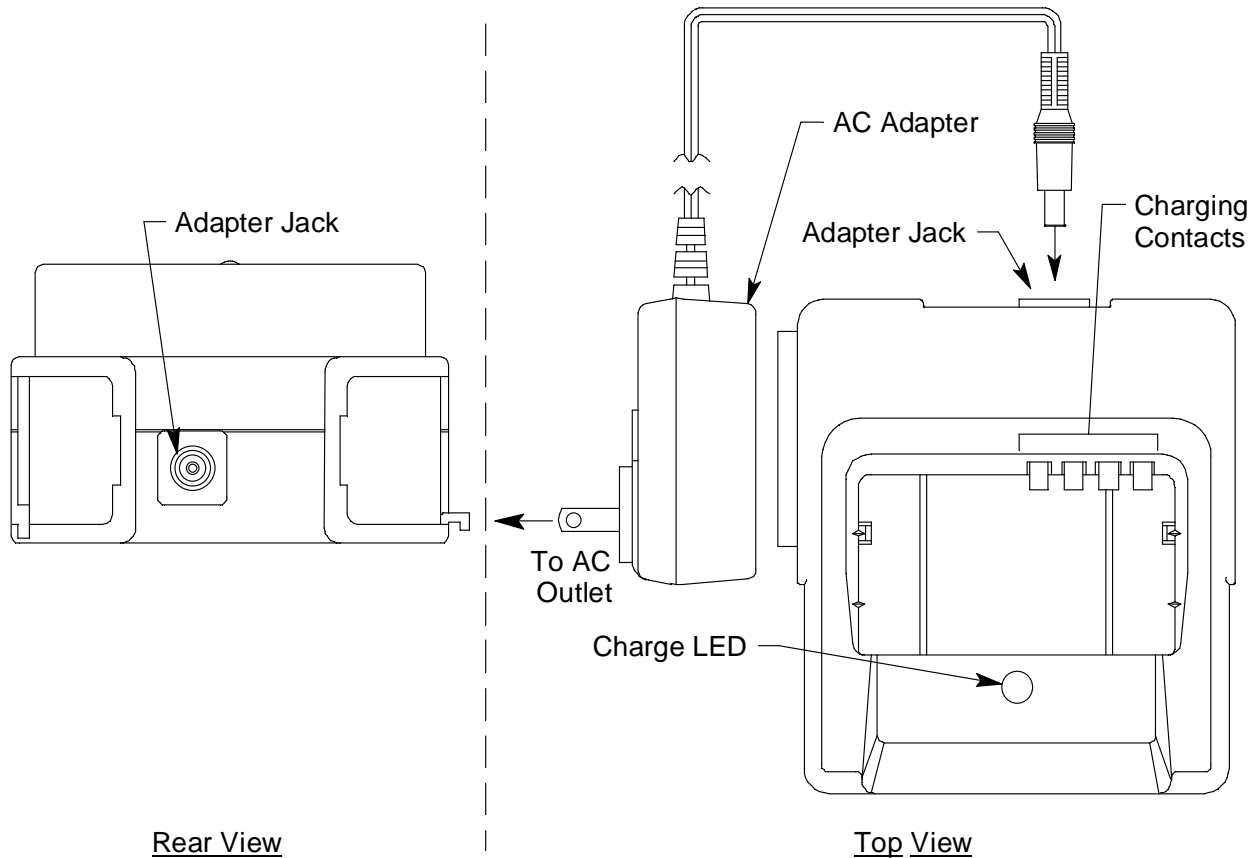

Figure 5: GX-212 AC Powered Charging Station

DC Powered Charging Station

An optional DC powered charging station is available with a vehicle plug 12 VDC adapter. It uses the same charging base as the AC charging station but comes with a velcro strap to secure the GX-2012 in the charging base.

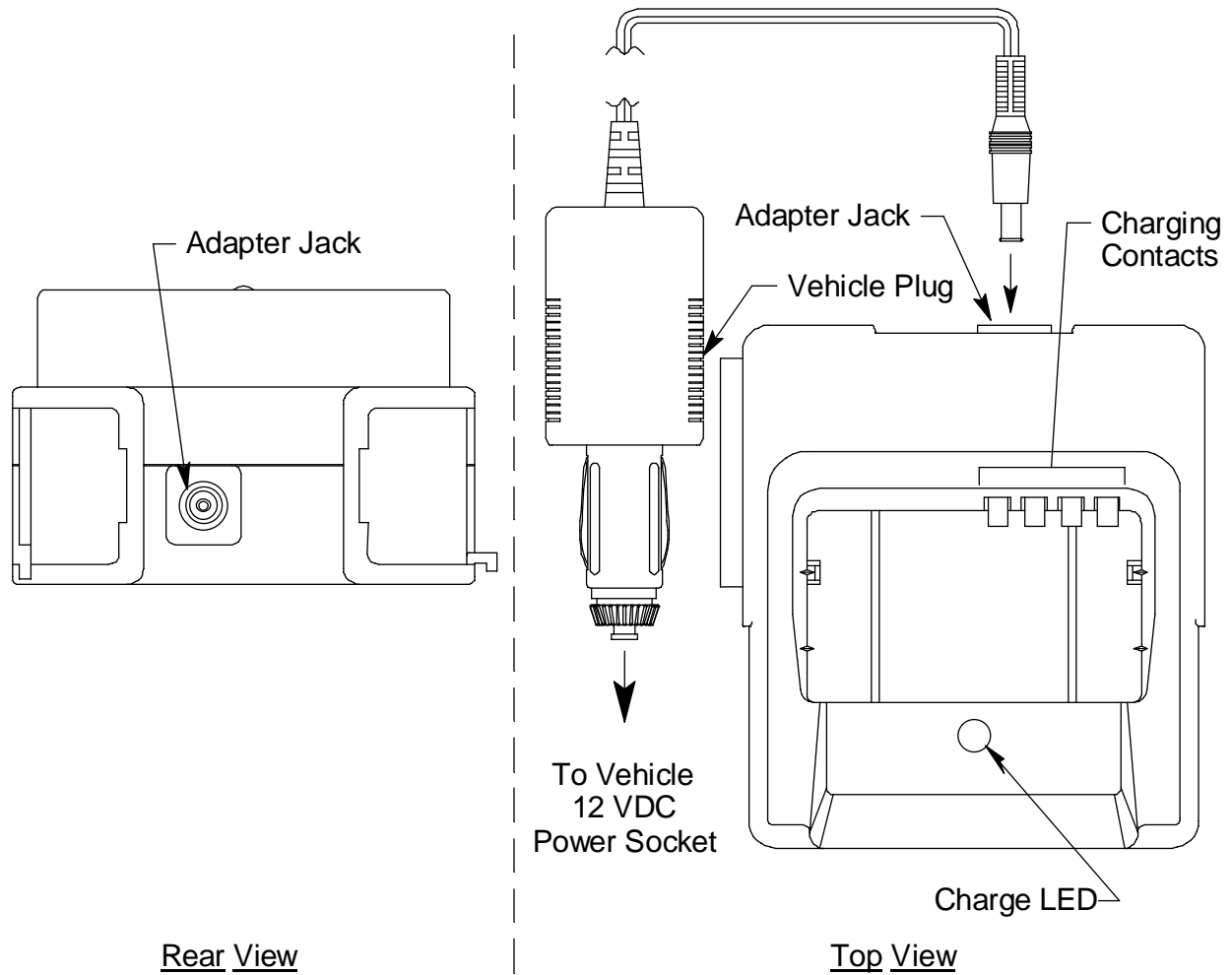

Figure 6: GX-2012 DC Powered Charging Station

Optional Probes

Various optional probes designed for specific applications are available for the GX-2012. They include the following:

- 30 inch aluminum probe

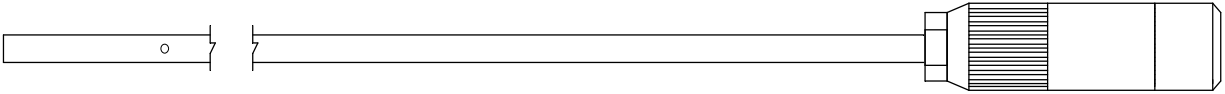

Figure 7: 30 Inch Aluminum Probe

This probe is designed for applications where it is necessary to put the probe tip in areas that are out of reach with the standard probe. A small breather hole near the end of the probe tube prevents interruption of sampling and a low flow alarm if the probe tip is blocked.

- 30 inch stainless steel probe

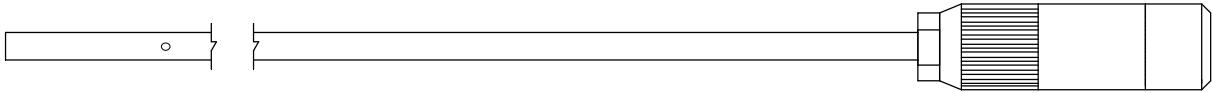

Figure 8: 30 Inch Stainless Steel Probe

This probe is physically the same as the 30 inch aluminum probe and is intended for applications where a high level of corrosion resistance is required in the long probe tube.

- Barhole probe

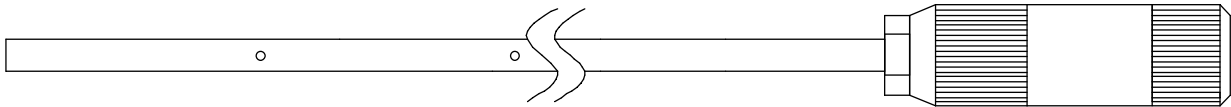

Figure 9: Barhole Probe

An optional bar hole probe is available for the GX-2012. It is designed to be used when the GX-2012 is operated in Bar Hole Mode to check bar holes when tracking down underground gas pipe leaks (see “Chapter 4: Using the GX-2012 in Bar Hole Mode” on page 71). The bar hole probe has the same handle as the standard probe, but has a 30 inch fiberglass tube instead of the standard tube. Four holes are drilled through the 30 inch tube’s wall near the end and the end is plugged so that debris from the barhole cannot be drawn into the tube. The sample is drawn through the drilled holes in the tube wall.

- 32 inch telescoping probe with dust filter

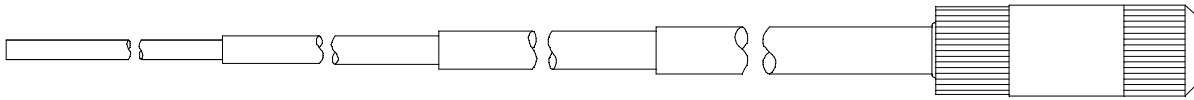

Figure 10: 32 Inch Telescoping Probe with Dust Filter

This probe is designed for use where it is necessary to put the probe tip in areas not accessible with the 10 inch probe with dust filter and applications where the probe tube must be collapsible for storage.

- 7 foot telescoping probe with dust filter

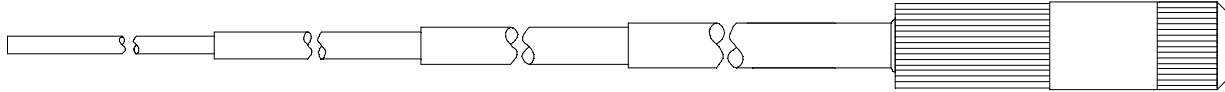
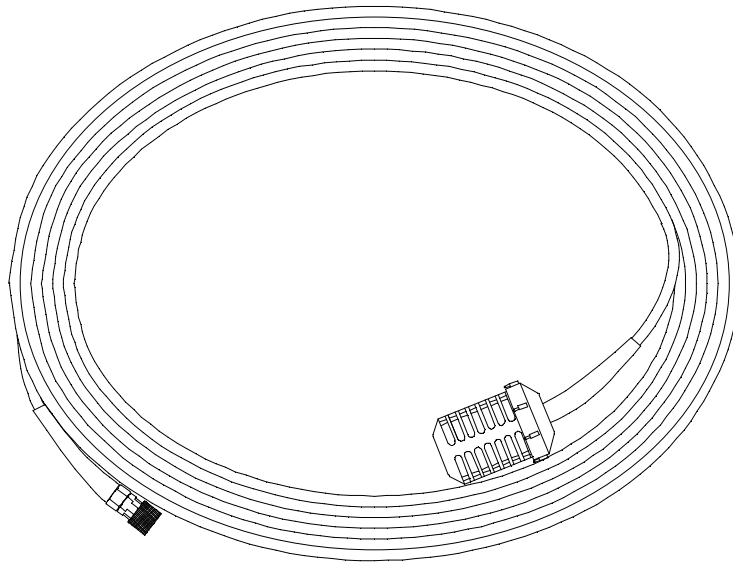

Figure 11: 7 Foot Telescoping Probe with Dust Filter

This probe is designed for use where it is necessary to put the probe tip in areas not accessible with the 32 inch telescoping probe with dust filter and applications where the probe tube must be collapsible for storage.

- 8 meter hose with floating head



This probe is designed to be used in a tank or a well that may have water or some other liquid at the bottom. As you lower the probe down, if it hits water, it will float and continue to monitor the area.

See the “Parts List” on page 138 for probe ordering information.

Purge Tee Fitting

The 17-4430RK-01 purge fitting is used to detect gas levels in a pressurized gas stream from a pipeline or vessel being purged. The sample port of the purge fitting is inserted into the flowing gas, and the vent port will allow any excess gas to release to the atmosphere to avoid damage to pump or sensors.

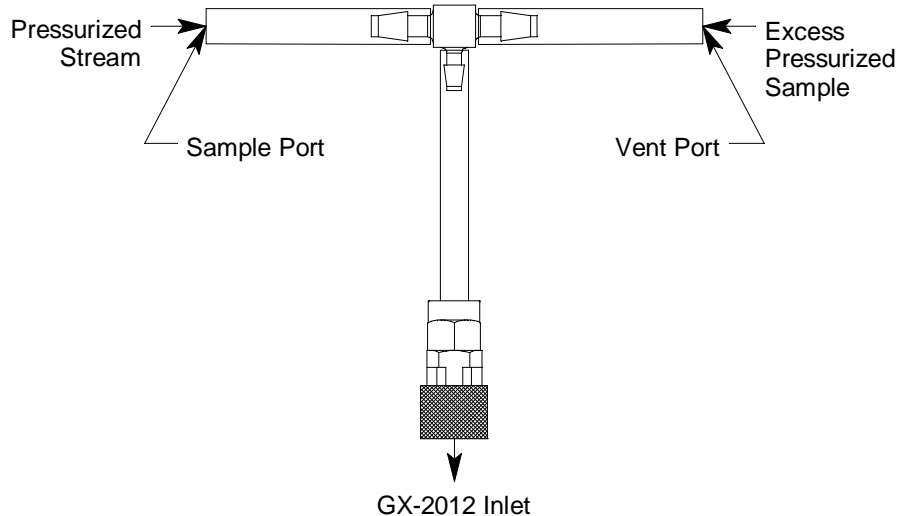

Figure 12: Purge Tee Fitting

External Dilution Fitting

An external dilution fitting is available for the GX-2012. It is a 1:1 dilution fitting and is designed to mate with the inlet fitting and accept a sample hose or probe. The fittings are made with brass and nickel plated brass and are appropriate for use with the four standard gases. The dilution fitting is normally used when it is necessary to introduce air into a sample that has no oxygen or a very low level of oxygen, such as a nitrogen purged sample. It can also be used when one of the target gas levels in the sample area will likely be present in a concentration above the detection range for that gas. Since the fittings partially consist of unplated brass, they are not appropriate for detection of elevated levels of H₂S.

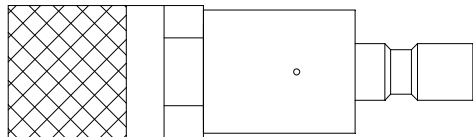

Figure 13: Dilution Fitting

Chapter 3: Using the GX-2012 in Normal Mode

Overview

This chapter explains how to operate the GX-2012 in Normal Mode. Normal Mode is used to perform confined space entry monitoring or general area monitoring. While in Normal Mode, Display Mode and Calibration Mode are accessible.

If a standard version of the GX-2012 is ordered, it is shipped with Bar Hole Mode disabled so that the instrument only runs in Normal Mode when turned on.

Start Up, Normal Mode

This section explains how to start up the GX-2012 in Normal Mode, get it ready for operation, and turn it off.

NOTE: The screens illustrated in this section are for a 4-gas unit that has the % LEL range for the combustible gas channel. The screens displayed by your GX-2012 may be slightly different.

Turning On the GX-2012, Normal Mode Only

The following description of the GX-2012 start up sequence assumes that the following items in Maintenance Mode are turned on: **LNCH BRK**, **ID DISP**, **CL RMNDR**, and **BP RMNDR**. If any of these items is turned off, then the corresponding screen will not appear. This description also assumes that Bar Hole Mode is not active.

1. Connect the tapered rubber nozzle or the sample hose to the GX-2012's quick connect inlet fitting.
2. If a sample hose is used, screw the probe onto the sample hose's threaded fitting.
3. Press and briefly hold down the POWER ENTER button. Release the button when you hear a beep.

4. If **LNCH BRK** is turned on, the Resume Datalog Screen displays.

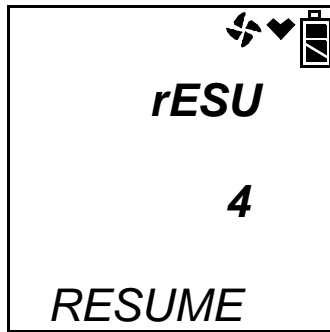

- Press and release the POWER ENTER button to continue accumulating time-weighted average (TWA), PEAK readings, and time in operation from the last time the GX-2012 was used. The short-term exposure limit [STEL] reading is reset each time the GX-2012 is turned on.
- Press and release the DISPLAY(ADJ) button to reset the accumulation of these measurements.

If you do not press the POWER ENTER or DISPLAY(ADJ) button within 5 seconds, the GX-2012 automatically resumes accumulating the TWA, PEAK readings, and time in operation.

5. If **CL RMNDR** is turned on (factory setting), the screen that appears next depends on how **CL EXPRD** is set in the Maintenance Mode Menu (page 112).
- If the unit is due for calibration and **CL EXPRD** is set to CONFIRM (factory setting), then the following screen displays.

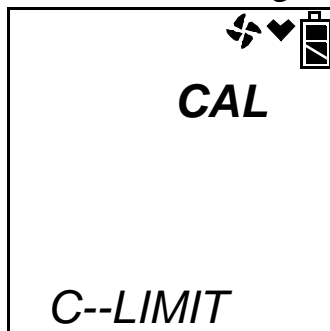

The alarm LED's and buzzer will pulse several times. After this, press the RESET SILENCE button until you hear a beep to continue.

- If the unit is due for calibration and **CL EXPRD** is set to NOT USE, then the following screen displays.

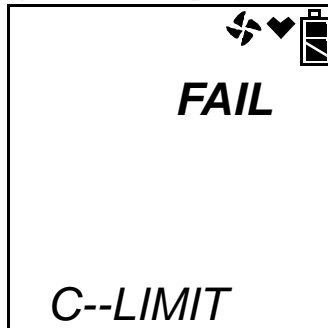

The GX-2012 cannot be used until a calibration has been performed either by selecting **AUTO CAL** or **ONE CAL** in the Maintenance Mode menu. See “Calibrating Using Auto Calibration” on page 86 or “Calibrating Using Single Calibration” on page 90 for calibration instructions.

- If calibration is not due or **CL EXPRD** is set to NO EFFECT, then the following screen appears for a few seconds indicating when the next calibration is due.

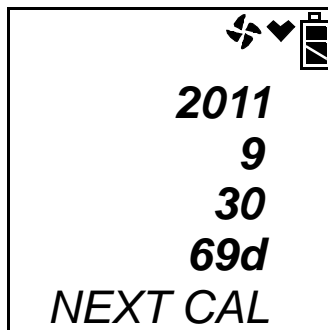

6. If **BP RMNDR** is turned on (factory setting is OFF), the screen that appears next depends on how **BP EXPRD** is set in the Maintenance Mode Menu (page 112).

- If the unit is due for a bump test and **BP EXPRD** is set to CONFIRM (factory setting), then the following screen displays.

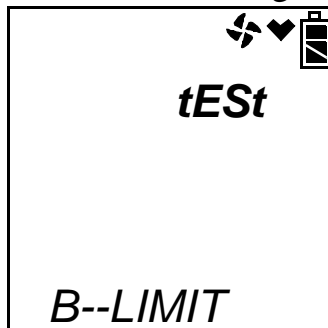

The alarm LED's and buzzer will pulse several times. After this, press the RESET SILENCE button until you hear a beep to continue.

- If the unit is due for a bump test and **BP EXPRD** is set to NOT USE, then the following screen displays.

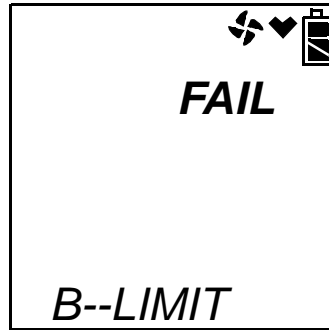

The GX-2012 cannot be used until a bump test has been performed by selecting **BUMP** in the Maintenance Mode menu. See “Performing a Bump Test” on page 92 for bump testing instructions.

- If a bump test is not due or **BP EXPRD** is set to NO EFFECT, then the following screen appears for a few seconds indicating when the next bump test is due.

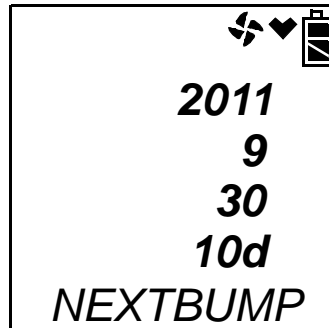

NOTE: If both **CL RMNDR** and **BP RMNDR** are turned off, a WARM UP screen will display before the warm up sequence continues.

7. If **ID DISP** is turned on (see page 116), the User ID Screen displays for a few seconds and then the Station ID Screen displays for a few seconds.

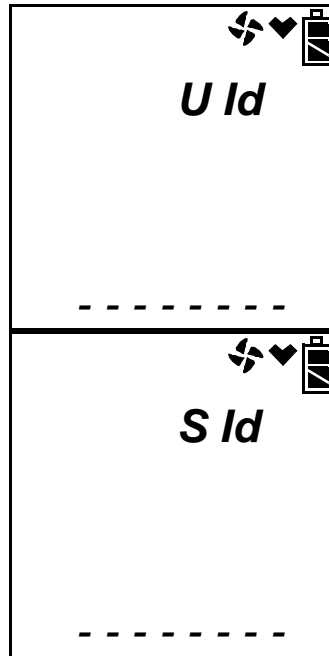

8. The Date/Time Screen appears for a few seconds.

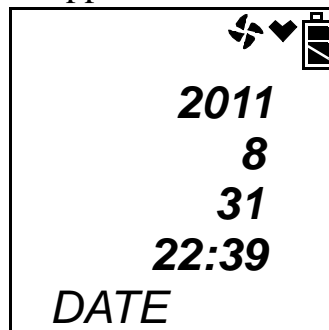

This screen displays the current year, month, day, and time.

9. The Battery Level and Alarm Pattern Screen appears next.

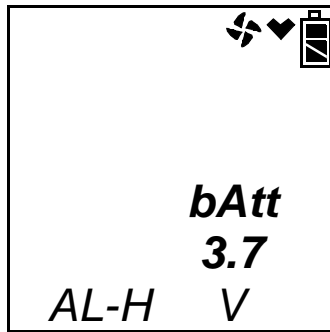

AL -- H indicates latching (hold) alarms and AL -- A indicates self-resetting (automatic) alarms. The number shown indicates the voltage of the batteries. A fully charged lithium ion battery pack will display 3.7 V. If the unit is powered by alkaline (dry cell) batteries, a “D” will appear in front of the “V” in the lower right corner.

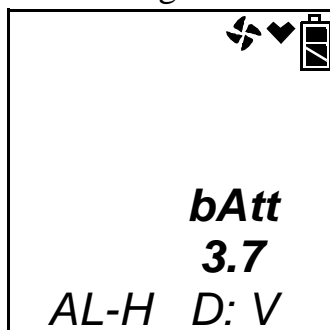

10. The display then indicates the following items for about a second each:

- Full scale values for all channels
- Warning setpoint (low gas alarm) for all channels
- Alarm setpoint (high gas alarm) for all channels
- STEL alarm setpoint for the CO and H₂S channels
- TWA alarm setpoint for the CO and H₂S channels

NOTE: If the combustible channel is factory set as % volume only, all gas alarms are turned off. You must press and release the RESET SILENCE button at the warning, alarm, STEL, and TWA screens to acknowledge that there are no gas alarms. The warm up will not proceed until you do so.

If the combustible channel is set up as % volume only using the HC Range Screen in Display Mode, it will automatically revert to Autoranging when it is turned off and on again and the no alarm acknowledgement screen will not appear.

11. If the GX-2012 experiences a sensor failure during start up, a screen indicating which sensor failed displays. In the example below, the CO sensor has failed.

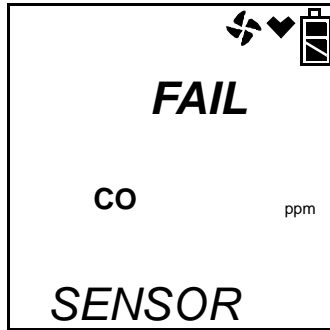

If you wish to continue, press and release the RESET SILENCE button to acknowledge the failure. The gas reading for the failed sensor will be replaced by “---”. Replace the failed sensor as soon as possible.

12. The GX-2012 is now operating in Normal Mode and monitoring for gas in Measuring Mode. The Normal Operation Screen appears.

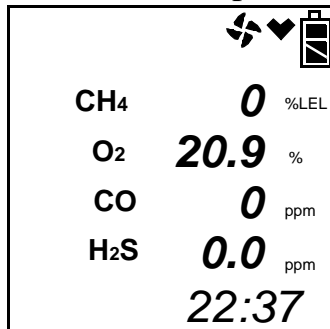

The concentrations of the target gases are displayed along with the time and battery charge level. The heart symbol displayed just to the left of the battery charge level flashes while the instrument is functioning properly. If it disappears or is steadily on, the unit is experiencing a microprocessor error. The fan symbol just to the left of the heart symbol spins while the pump is operating.

Turning On the GX-2012 in Normal Mode With All Modes Active

If the **L./B. MODE** item in Maintenance Mode is set to bH (see “Updating the Leak Check/Bar Hole Mode Setting” on page 118), then the user must select Normal Mode during the start up sequence to operate in Normal Mode. The standard factory setting for **L./B. MODE** is OFF. See “Chapter 4: Using the GX-2012 in Bar Hole Mode” on page 71 for a description of Bar Hole Mode.

The following description of the GX-2012 start up sequence assumes that the following menu items in Maintenance Mode are turned on: **LNCH BRK**, **ID DISP**, **CL RMNDR**, and **BP RMNDR**. If any of these items is turned off,

then the corresponding screen will not appear. It also assumes that the **L./B. MODE** menu item in Maintenance Mode is set to bH. If **L./B. MODE** is set to OFF, the Bar Hole Mode Select Screen will not appear.

1. Connect the tapered rubber nozzle or the sample hose to the GX-2012's quick connect inlet fitting.
2. If a sample hose is used, screw the probe onto the sample hose's threaded fitting.
3. Press and briefly hold down the POWER ENTER button. The Normal Mode Select Screen displays.

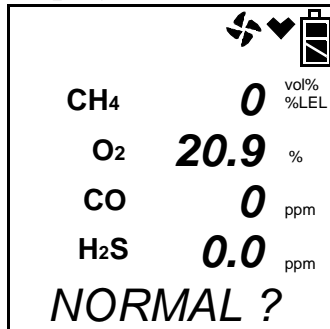

4. You can use the AIR▲ or (SHIFT)▼ button to scroll to the Bar Hole Mode Select Screen.

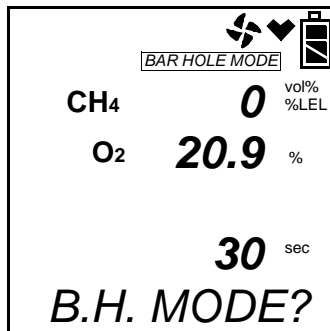

You can also use the AIR▲ or (SHIFT)▼ buttons to move back and forth between the two screens.

5. With the Normal Mode Select Screen displayed, press and release the POWER ENTER button and continue with the startup sequence as described in the previous section, "Turning On the GX-2012, Normal Mode Only", from step 4 on page 20 on.

NOTE: If no button is pressed for 20 seconds, the unit will proceed into whichever mode is displayed.

6. To exit Normal Mode and return to the Mode Select Screen, press and hold the (SHIFT)▼ button for 5 seconds while in the Normal Operation Screen.

Performing a Fresh Air Adjustment, Normal Mode

Before using the GX-2012, it is recommended to set the fresh air readings for the target gases by performing a fresh air adjustment. This will set the combustible gas, CO, and H₂S channels to zero and the OXY channel to 20.9%.

1. Find a fresh-air environment. This is an environment free of toxic or combustible gases and of normal oxygen content (20.9%).
2. Turn on the unit as described above in “Turning On the GX-2012, Normal Mode Only” or “Turning On the GX-2012 in Normal Mode With All Modes Active”.
3. Press and hold the AIR▲ button. The display prompts you to hold the AIR▲ button.

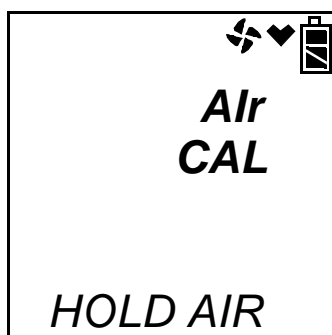

4. Continue to hold the AIR▲ button until the display prompts you to release the AIR▲ button. The GX-2012 will count down from 8 on an autoranging combustible gas channel as it sets the fresh air reading for all channels. Once the countdown has finished, start up is complete and the unit is ready for monitoring.

Turning Off the GX-2012, Normal Mode

1. Press and hold the POWER ENTER button.
2. The buzzer will pulse for about three seconds and TURN OFF will be displayed along the bottom of the screen.
3. Release the button when TURN OFF disappears.

Measuring Mode, Normal Operation

The GX-2012 has three operating modes within Normal Mode: Measuring Mode, Display Mode, and Calibration Mode. This section describes using the GX-2012 in Measuring Mode during normal operation.

In Measuring Mode the GX-2012 continuously monitors the sampled atmosphere and displays the gas concentrations present for its target gases. In a low-light environment, press and release any button to turn on the display backlight. See “Updating the LCD Back Light Time Setting” on page 116 to program backlight duration. If the **BEEP. SET** menu item in Maintenance Mode is turned on, the GX-2012 beeps once every 5 minutes to confirm that it’s operating. See “Updating the Confirmation Beep Setting” on page 110 for instructions to update the setting.

Monitoring an Area

1. Start up the GX-2012 as described above in “Start Up, Normal Mode” on page 19 or “Turning On the GX-2012 in Normal Mode With All Modes Active”. It is now in Measuring Mode.

2. Take the GX-2012 to the monitoring area.

If the tapered rubber nozzle is used, put the nozzle tip in the area to be monitored.

If the hose and probe is used, put the probe tip in the area to be monitored.

3. Wait 10 - 15 seconds and observe the display for gas readings. If a reading is observed, allow the reading to stabilize to determine the gas concentrations present.

NOTE: Response time increases with the length of the sample hose. Long sample hoses will require more time to show a response at the GX-2012. The maximum sample hose length recommended for the GX-2012 is 50 feet. Consult RKI Instruments, Inc. for longer sample hose lengths.

4. If a gas alarm occurs, take appropriate action. See “Responding to Alarms” on page 38.

Using Optional Probes and Fittings

This section describes how to use the 8 meter hose with floating head and the purge tee fitting.

Using the 8 Meter Hose with Floating Head

This probe is designed to be used in a tank or a well that may have water or some other liquid at the bottom. To use the 8 meter hose with floating probe:

1. Start up the GX-2012 as described in “Start Up, Normal Mode” on page 19.
2. Connect the 8 meter hose with floating probe to the GX-2012’s quick connect inlet fitting.
3. Slowly lower the probe into the area you wish to monitor. If the probe hits water, it will float and continue to monitor the area.

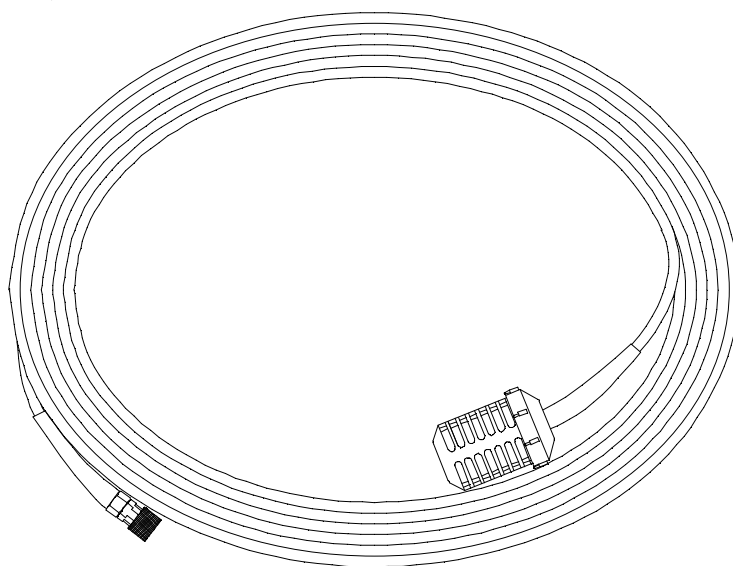

Figure 14: 8 Meter Hose with Floating Head

Using the Purge Tee Fitting

The purge fitting is used to detect gas levels in a pressurized gas stream from a pipeline or vessel being purged.

1. Start up the GX-2012 as described in “Start Up, Normal Mode” on page 19.
2. Connect the purge tee fitting to the GX-2012’s quick connect inlet fitting.

3. Insert the sample port into the flowing gas. The vent port will allow any excess gas to release to the atmosphere to avoid damage to pump or sensors.

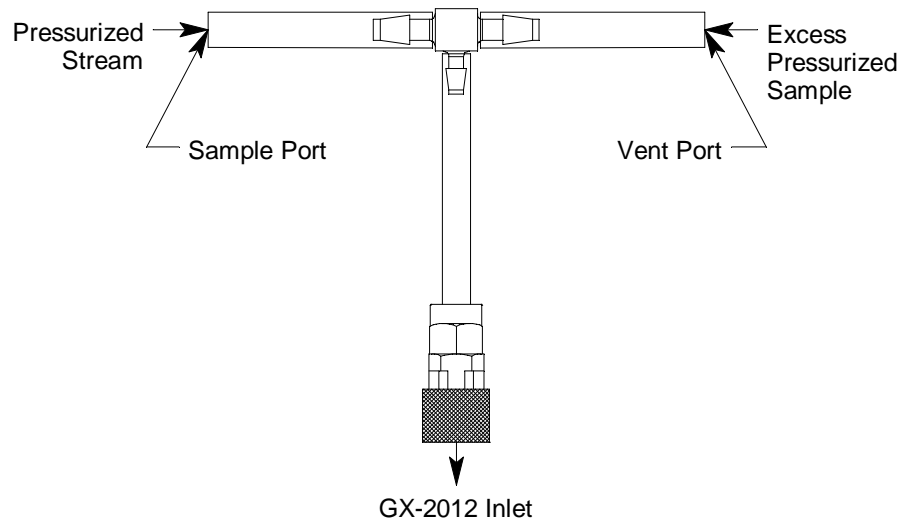

Figure 15: Purge Tee Fitting

Using the Dilution Fitting

The external dilution fitting is a 1:1 dilution fitting. It is normally used when it is necessary to introduce air into a sample that has no oxygen or a very low level of oxygen, such as a nitrogen purged sample. It can also be used when one of the target gas levels in the sample area will likely be present in a concentration above the detection range for that gas. Since the fittings partially consist of unplated brass, they are not appropriate for detection of elevated levels of H₂S.

1. Start up the GX-2012 as described in “Start Up, Normal Mode” on page 19.
2. Install the dilution fitting to the GX-2012’s quick connect inlet fitting.
3. Connect the tapered rubber nozzle or the sample hose to the GX-2012’s quick connect inlet fitting.
4. If a sample hose is used, screw the probe onto the sample hose’s threaded fitting.
5. Monitor the sampling area.

NOTE: The GX-2012 can be calibrated either with or without the dilution fitting in place. If calibrated without the dilution fitting in place, then display readings must be doubled to determine the actual gas concentration. If calibrated with the dilution fitting in place, then a sample bag must be used during calibration, and the display readings will be the actual gas concentrations.

CAUTION: *If the dilution fitting is in place for calibration, do not use a demand flow regulator. Use a sample bag. The use of a demand flow regulator with a dilution fitting when calibrating will result in an inaccurate calibration.*

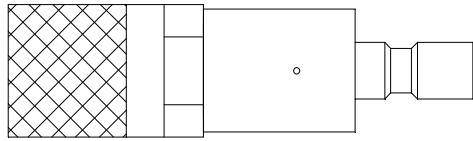

Figure 16: Dilution Fitting

Combustible Gas Detection

The GX-2012 can support two combustible gas sensors, a TC (thermal conductivity) sensor for detection in the % volume range, and a catalytic sensor for detection in the % LEL range. Either or both sensors may be installed in your unit.

If both the % volume and % LEL sensors are installed, the combustible gas channel is setup at the factory as % LEL/% volume autoranging. In this case, the combustible gas channel will display the combustible gas concentration in % LEL up to 100% LEL. If the combustible gas concentration rises above 100% LEL, then the unit automatically begins displaying the concentration in % volume.

CAUTION: *If the combustible channel is set for %volume only, then there are no gas alarms for any detection channel. See “HC Range Screen” on page 43.*

There are three issues to keep in mind when monitoring for combustible gas.

- If your GX-2012 is equipped with the %LEL and %volume sensors, then the % LEL sensor will be exposed to combustible gas concentrations above its working range during monitoring and calibration. The GX-2012 provides the % LEL sensor with protection against exposure to high levels of combustible gas. It does this by turning off the % LEL sensor power temporarily when it determines that a %LEL over scale (more than 100% LEL) concentration of combustible gas is present that may damage the sensor. When this happens, “OVER” is displayed below the gas list and the display units to the right of the combustible gas channel change to % volume.
- Silicone vapors and chlorine and fluorine compounds, such as chlorinated hydrocarbons, can damage the %LEL sensor. These compounds should be avoided. If exposure to these compounds is suspected, verify the %LEL response on a known gas sample.

- Although the standard factory setup and calibration for the combustible gas channel is to methane (CH₄), the combustible sensors will respond to other combustible gases as well.

The table below lists the conversion factors for several hydrocarbon gases **for the % LEL combustible sensor if it is calibrated to methane.**

Conversion factors are not available for the % volume TC sensor. To use this table, multiply the display reading on the combustible gas channel by the factor in the appropriate row to obtain the actual gas concentration. For example, if you are detecting pentane and the display reads 10% LEL on the combustible gas channel, you actually have 10% LEL x 1.35 = 13.5% LEL pentane present.

Table 3: LEL Hydrocarbon Conversions

Gas	LEL Conversion Factor (Methane Calibration)	Gas	LEL Conversion Factor (Methane Calibration)
Acetone	1.92	Iso Butane	1.56
Acetylene	2.00	MEK	1.92
Benzene	2.00	Methane	1.00
Ethane	1.25	Methanol	1.65
Ethanol	1.75	Pentane	1.35
Ethylene	1.20	Propane	1.52
Heptane	1.92	Propylene	1.33
Hexane	1.65	Toluene	2.00
Hydrogen	1.00	Xylene	0.93
IPA	2.50		

Snap Log Mode

The snap logging function in Snap Log Mode allows the user to record data at a specific time and have it saved to the data logger. The data is assigned a snap log ID and is saved with the station ID that was in use when the data was taken.

To enter Snap Log Mode and record snap log data:

1. Press and hold the (SHIFT)▼ button, then press and hold the AIR▲ button and hold both until you hear a beep. The unit will cycle through the following screens.

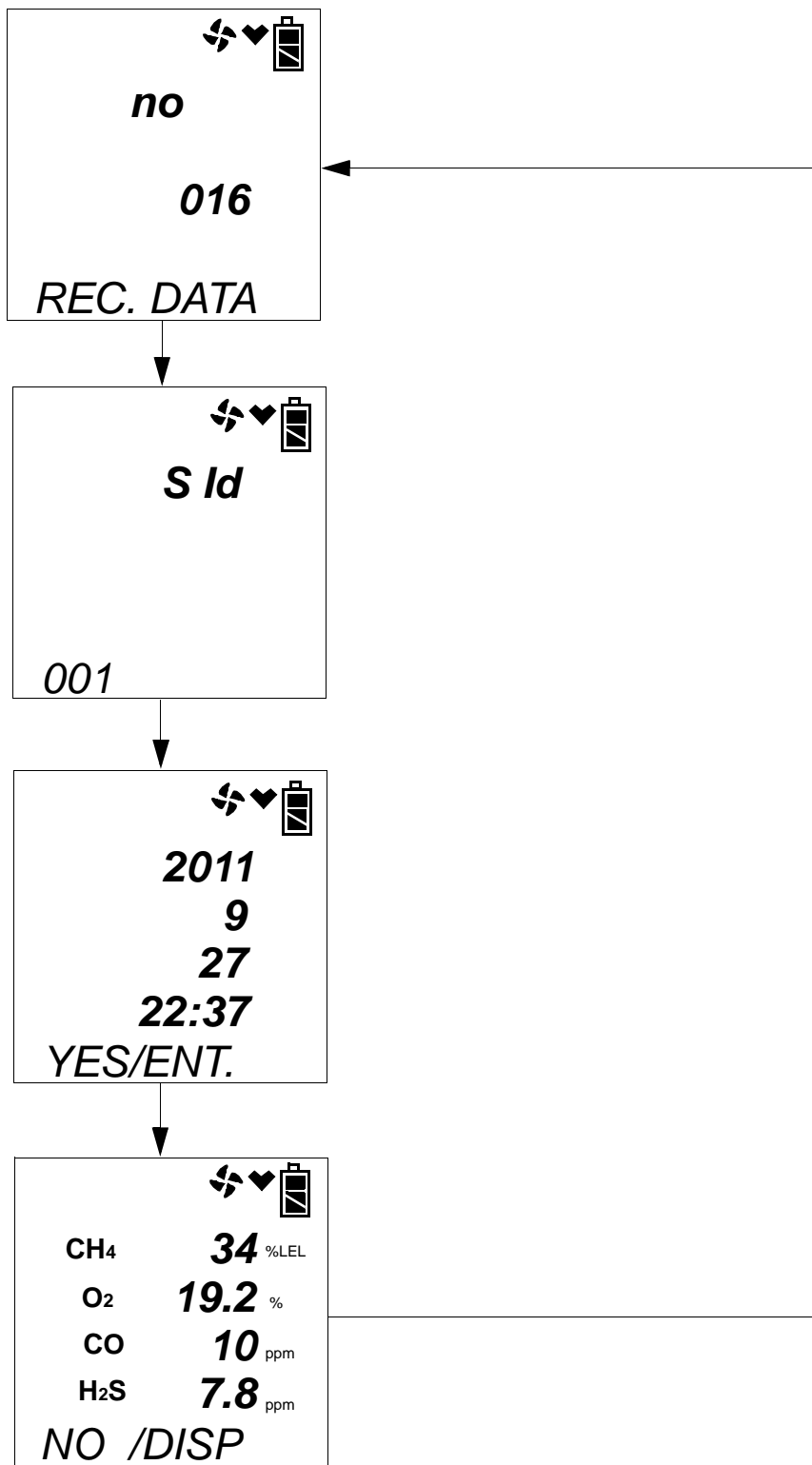

The first screen displays what snap log ID will be given to this particular set of data. This ID number increases sequentially with each set of snap log data taken. The second screen displays what Station ID will be associated with this snap log. The third screen displays the year, month,

day, and time of the snap log, and that you should press the POWER ENTER button to save a set of snap log data. The fourth screen displays the current gas readings, and that you should press the DISPLAY (ADJ) button to exit Snap Log Mode without saving a set of snap log data.

2. You can change the Station ID to be used with the snap log by pressing the (SHIFT)▼ button and then pressing the DISPLAY (ADJ) button. The Station ID Select Screen will appear and the current Station ID will be flashing.

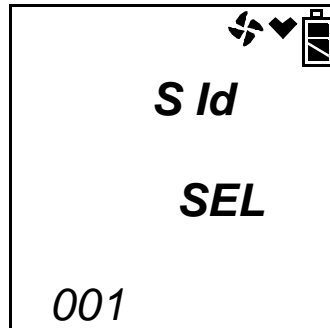

3. Use the (SHIFT)▼ and AIR▲ buttons to scroll to the desired station ID, then press and release the POWER ENTER button to return to the Snap Logging Screen sequence.

To return to the Snap Logging Screen sequence without changing the station ID, press and release RESET SILENCE.

4. To take a snap log of the current gas readings, press and release the POWER ENTER button. The unit will display SAVED along the bottom of the screen before returning to the Snap Logging Screen sequence.

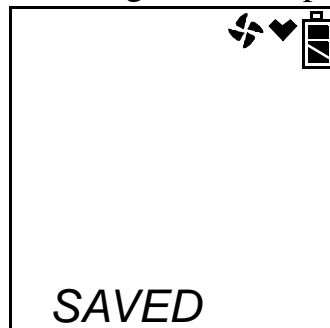

To exit Snap Log Mode without taking a snap log or when you are finished recording snap logs, press and release the DISPLAY (ADJ) button. The unit will immediately return to the Normal Operation Screen.

5. The data recorded in Snap Log Mode can be viewed in Display Mode. See “Snap Logging Screen” on page 52 for more information.

Measuring Mode, Alarms

This section covers alarm indications in Measuring Mode. It also tells you how to reset the GX-2012 after an alarm has occurred and how to respond to an alarm condition.

NOTE: False alarms may be caused by radio frequency (RF) or electromagnetic (EMI) interference. Keep the GX-2012 away from RF and EMI sources such as radio transmitters or large motors.

Alarm Indications

CAUTION: *If the combustible channel is set for %volume only, then there are no gas alarms for any detection channel. See “HC Range Screen” on page 43.*

The GX-2012 will sound an alarm, the unit will vibrate, and the LED arrays will flash when one of the target gas concentrations rises above the Warning level, or in the case of oxygen, falls below the Low Alarm setting for that gas.

The GX-2012 also sounds an alarm, vibrates, and flashes the LED arrays when the Alarm level is reached for combustible gas, CO, and H₂S, when the concentration of oxygen rises above the High Alarm level, and when the STEL and TWA alarm points are reached for CO and H₂S.

When a failure condition occurs, such as a sensor failure, low flow, or dead battery condition, the unit will also sound an alarm, flash the LED arrays, and vibrate.

The table below summarizes the types of alarms produced by the GX-2012.

Table 4: Alarm Types and Indications

Alarm Type	Visual Indications	Other Indications
Low Alarm Concentration of gas rises above the Warning level, or falls below the Low Alarm level for O ₂ .	<ul style="list-style-type: none">• WARNING appears below the gas list.• Reading for the gas in alarm flashes• Alarm LED arrays flash• Backlight turns on	<ul style="list-style-type: none">• Buzzer sounds alternating between a low and high pitch• Vibrator pulses

Table 4: Alarm Types and Indications

Alarm Type	Visual Indications	Other Indications
<p>High Alarm</p> <p>Concentration of gas rises above the Alarm level, or rises above the High Alarm level for O₂.</p>	<ul style="list-style-type: none"> • ALARM appears below the gas list. • Reading for the gas in alarm flashes • Alarm LEDs flash faster than warning indication • Backlight turns on 	<ul style="list-style-type: none"> • Buzzer sounds alternating between low and high pitch faster than warning indication • Vibrator pulses faster than warning indication
<p>TWA or STEL</p> <p>Concentration of CO or H₂S rises above the TWA or STEL alarm point setting.</p>	<ul style="list-style-type: none"> • TWA or STEL appears below the gas list. • Alarm LEDs flash • Back light turns on 	<ul style="list-style-type: none"> • Buzzer sounds alternating between a low and high pitch at the same rate as warning indication • Vibrator pulses at same rate as warning indication
<p>Over Range*</p>	<ul style="list-style-type: none"> • Gas reading replaced by brackets flashing at same rate as alarm indication □□□□ • Alarm LEDs flash at same rate as alarm indication • Back light turns on. • OVER appears below the gas list. 	<ul style="list-style-type: none"> • Buzzer sounds alternating between a low and high pitch at same rate as alarm indication • Vibrator pulses at same rate as alarm indication
<p>Low Flow*</p>	<ul style="list-style-type: none"> • The display indicates FAIL LOW FLOW • The Alarm LED's flash 	<ul style="list-style-type: none"> • Buzzer sounds a double pulsing tone (two pulses in quick succession)
<p>Low Battery Warning*</p>	<ul style="list-style-type: none"> • Battery icon blinks 	<ul style="list-style-type: none"> • None
<p>Dead Battery Alarm*</p>	<ul style="list-style-type: none"> • Gas readings replaced by FAIL • Fan symbol disappears • BATTERY displayed along bottom of screen • Alarm LED arrays flash 	<p>Buzzer sounds a double pulsing tone (two pulses in quick succession)</p>

Table 4: Alarm Types and Indications

Alarm Type	Visual Indications	Other Indications
Sensor Failure*	<ul style="list-style-type: none"> • FAIL appears at the bottom of the display and the failed sensor(s) are indicated • Alarm LED arrays flash 	Buzzer sounds a double pulsing tone (two pulses in quick succession)
Clock Failure*	<ul style="list-style-type: none"> • FAIL CLOCK appears on the display • Alarm LED arrays flash 	Buzzer sounds a double pulsing tone (two pulses in quick succession)
System Failure*	<ul style="list-style-type: none"> • FAIL SYSTEM appears on the display • Alarm LED arrays flash 	<ul style="list-style-type: none"> • Buzzer sounds a double pulsing tone (two pulses in quick succession) • A failure code appears
<p>Microprocessor Failure*</p> <ul style="list-style-type: none"> • NOTE: The unit will not operate if this alarm occurs. 	<ul style="list-style-type: none"> • Heart indicator is steadily on or not on at all 	<ul style="list-style-type: none"> • None
*This alarm can also occur in Bar Hole Mode		

Resetting and Silencing Alarms

You can set the GX-2012's gas alarms as latching or self-resetting alarms (see "Updating the Alarm Latching Setting" on page 98) and the buzzer operation as silenceable or not silenceable (see "Updating the Alarm Silence Setting" on page 99).

- Self-resetting alarms (**LATCHING** set to OFF)

Self-resetting alarms automatically shut off and reset when the gas reading falls below (or rises above for an oxygen low alarm) the alarm setting. You cannot silence or reset self-resetting alarms.

- Latching alarms (**LATCHING** set to ON)

You can set latching alarms with or without Alarm Silence (see "Updating the Alarm Silence Setting" on page 99).

With ALRM SLNC On and LATCHING On:

When the GX-2012 goes into a gas alarm, press the RESET SILENCE button to silence the buzzer. If the gas concentration was still above the alarm level when the button was pressed, the LEDs continue to flash, and the GX-2012

continues to display the current alarm level.

The gas reading must fall below (or rise above for an oxygen low alarm) the low alarm setting before you can reset the alarm. Press the RESET SILENCE button to reset the alarm. The LEDs turn off and the GX-2012 alarm indications on the display turn off.

With ALRM SLNC OFF and LATCHING ON:

The gas reading must fall below (or rise above for an oxygen low alarm) the low alarm setting before you can reset the alarm. Press the RESET SILENCE button to reset the alarm. The LEDs and buzzer turn off and the GX-2012 alarm indications on the display turn off.

NOTE: With **ALRM SLNC** set to OFF in Maintenance Mode, you cannot silence the buzzer while the gas reading is above (below for an oxygen Low Alarm) the low alarm setting.

Responding to Alarms

This section describes response to gas, over range, battery, and sensor failure alarms.

Responding to Gas Alarms

1. Determine which gas alarm has been activated.
2. Follow your established procedure for an increasing gas condition or a decreasing oxygen condition.
3. If necessary, reset the alarm using the RESET SILENCE button once the alarm condition has been cleared.

Responding to Over Range Alarms

WARNING: *An over range alarm may indicate an extreme combustible gas, toxic gas, or oxygen concentration. Confirm a normal condition with a different GX-2012 or with another gas detecting device.*

1. Determine which gas alarm has been activated.
2. Follow your established procedure for an increasing gas condition.
3. Reset the alarm using the RESET SILENCE button once the alarm condition has cleared.
4. Calibrate the GX-2012 as described in the calibration section of this manual.

5. If the over range condition continues, you may need to replace the sensor that has triggered the over range alarm.
6. If the over range condition continues after you have replaced the sensor, contact RKI Instruments, Inc. for further instructions.

Responding to Battery Alarms

WARNING: *The GX-2012 is not operational as a gas monitoring device during a dead battery alarm. Take the GX-2012 to a non-hazardous area and replace or recharge the batteries as described in “Replacing or Recharging the Batteries” on page 126.*

The GX-2012 is fully functional during a low battery warning. However, only a limited amount of operating time remains, approximately 1 - 2 hours. The amount of time depends on how often the LCD backlight is used and how often the unit is responding to alarm conditions. Recharge the battery pack or replace the alkaline batteries as soon as possible as described in “Replacing or Recharging the Batteries” on page 126.

NOTE: Alarms and the back light feature consume battery power and reduce the amount of operating time remaining.

Responding to Sensor Failure Alarms

1. Determine which sensor has triggered the sensor failure alarm.
2. Try calibrating the sensor first, as described in “Calibration Mode” on page 56 before replacing it.
3. If the sensor failure continues, replace the sensor as described in “Replacing a Sensor” on page 135.
4. If the sensor failure condition continues after you have replaced the sensor, contact RKI Instruments, Inc. for further instructions.

Responding to Clock Failure Alarm

This alarm occurs if the internal unit date has been changed to something unreasonable like 15/34 (month/day).

1. Press and release the RESET SILENCE button to continue into normal operation.

CAUTION: *There will be no datalogging function if you operate the instrument after a clock failure.*

2. Attempt to change the date using the **DATE** menu time in Maintenance Mode. See “Updating the Date and Time Settings” on page 85.
3. If the date cannot be set correctly, contact RKI Instruments, Inc. as soon as possible.

Responding to System Failure Alarms

1. If a system failure occurs, the system failure screen will display an error code as shown below:

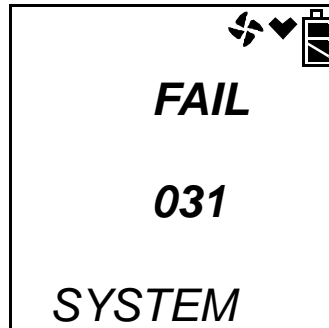

2. The error code meanings are shown below:

Table 5: Error Code Explanation

Error Code	Explanation
000	MPU failure
010	RAM failure
021	EEPROM failure
031	FLASH memory failure

3. If the error code is anything but 031 as shown above, the instrument cannot be used. Contact RKI Instruments, Inc. as soon as possible.

If the error code is 031, you may press and release the **RESET SILENCE** button to continue to normal operation if the instrument must be used temporarily.

CAUTION: *There will be no datalogging function if you operate the instrument after a 031 system failure. Contact RKI Instruments, Inc. as soon as possible.*

Responding to Microprocessor Failure

If your unit experiences a microprocessor failure, the heart symbol at the top of the screen will be steadily on or steadily off. The unit cannot be used in this case. Contact RKI Instruments, Inc. as soon as possible.

Inert Mode

Inert Mode is used to measure the combustible gas and/or oxygen level in a purged environment. In order for the instrument to operate in Inert Mode, the oxygen alarm must be set to H-HH operation in which both alarms are increasing. The oxygen Warning and Alarm points are factory set at 5.0% and 10.0%.

It is recommended that the %volume sensor be installed in a unit that is used to monitor combustible gas during Inert Mode operation since it does not require oxygen to work properly. The catalytic LEL sensor does not operate at oxygen concentrations below 10% volume. If it is necessary to use the catalytic LEL sensor during Inert Mode operation, a dilution fitting must be installed. Installing a dilution fitting will affect the oxygen reading since you're introducing oxygen into the sample.

Alarms

The oxygen channel alarm points in Inert Mode are different from those in Normal Mode. All other alarm point settings remain unchanged.

Since the application for Inert Mode is to detect a rising oxygen level in purged environments, both oxygen alarms are set to rising. The factory set alarm point is 5.0% volume for the Warning and 10.0% volume for the Alarm. These alarm points are user adjustable in Maintenance Mode. See "Updating the Alarm Point Settings" on page 101 for instructions to set the alarm points.

Start Up and Operation

1. With the oxygen alarm pattern set to H-HH, start up the Gas Tracer as described in "Turning On the GX-2012, Normal Mode Only" on page 19.

2. Once the warm up sequence is complete, the Normal Operation Screen will display and INERT will appear along the bottom of the display.

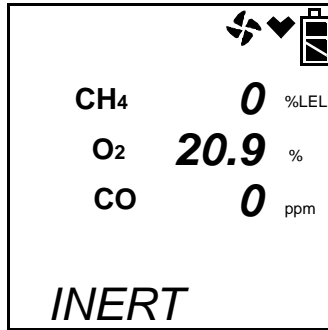

3. Since the oxygen concentration in fresh air is above both oxygen alarm points, the Gas Tracer will go into alarm if turned on in a fresh air environment.

Display Mode

This section describes using the GX-2012 in Display Mode. With the GX-2012 in Display Mode, you can:

- set the combustible gas channel range
- display peak readings
- display STEL and TWA readings (*H₂S and CO only*)
- display full scale, warning, alarm, STEL, and TWA (*H₂S and CO only*) values
- display time in operation
- display the date and time
- display remaining log time
- clear the data logger
- turn the pump on or off
- select a user ID
- select a station ID
- display snap logging data
- turn peak bar function on or off

To enter Display Mode, press and release the DISPLAY (ADJ) button while in Measuring Mode. To scroll from one screen to the next press and release the DISPLAY (ADJ) button.

NOTE: Each screen displays for 20 seconds. If you do not press the DISPLAY (ADJ) button to scroll to the next screen or press the POWER ENTER button to enter an item within 20 seconds, the GX-2012 automatically returns to Measuring Mode.

HC Range Screen

This screen displays only if your GX-2012 is equipped with both the catalytic % LEL combustible sensor and the TC % volume combustible sensor. It allows you to select the display units for the combustible channel as % LEL/% volume autoranging or % volume. If autoranging is selected, the combustible gas reading will be displayed in % LEL up to 100% LEL, which is equivalent to 5% volume for methane (CH₄). Above 100% LEL, it will be displayed in % volume. If % volume is selected, the combustible gas reading will be displayed in % volume only.

CAUTION: *If the combustible channel is set for % volume only, then there are no gas alarms for any detection channel and NO ALARM will appear in the upper left corner of the screen when you return to normal operation.*

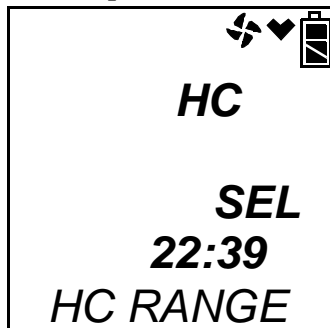

To update the HC range setting:

1. After entering Display Mode and arriving at the HC Range Screen, press and release the POWER ENTER button. The current setting will appear at the bottom of the LCD.
2. Use the AIR▲ or (SHIFT)▼ button to change the setting.
3. Press the POWER ENTER button to save the change.
4. Press the DISPLAY (ADJ) button to advance to the next screen.

Peak Screen

The Peak Screen displays the highest (lowest for O₂) concentrations detected since the GX-2012 was turned on. Peak readings are stored in the GX-2012's memory until a higher level is detected, the peak reading is reset, or the GX-2012 is turned off.

The lunch break feature enables the GX-2012 to remember peak readings when it is turned off so it can continue them when it is turned on again. See “Turning On the GX-2012, Normal Mode Only” on page 19. To reset the peak readings during operation, press and hold the RESET SILENCE button for a few seconds while in the peak screen.

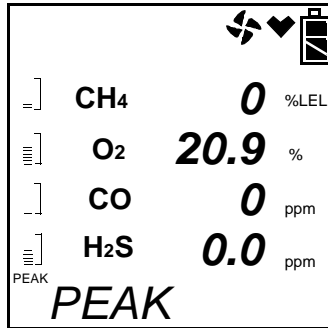

STEL Screen

The STEL Screen displays the short-term exposure limit (STEL) readings for CO and H₂S only. The STEL reading is the average reading during the last 15 minutes.

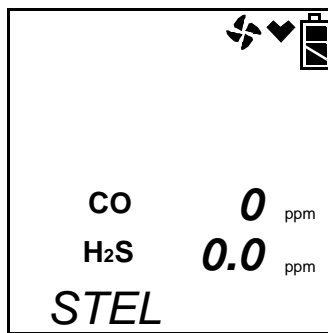

TWA Screen

The TWA Screen displays the time-weighted average (TWA) readings for CO and H₂S only.

The TWA reading is the average reading during the last 8 hours. If 8 hours have not elapsed since the last time the TWA reading was cleared, the average is still calculated over 8 hours. The missing time is assigned a 0 value for readings.

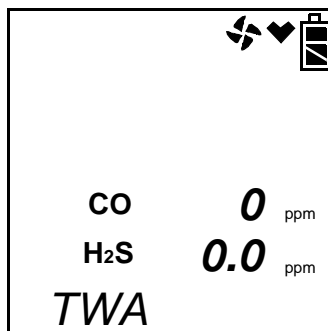

Alarm Points Screen

The Alarm Points Screen allows you to view each channel's alarm settings for full scale, warning, alarm, STEL (for CO and H₂S only), and TWA (for CO and H₂S only). The bottom line of the screen will alternate between ALARM--P, NO /DISP, and YES/ENT.

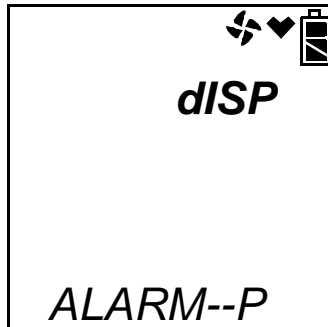

Press the POWER ENTER button to proceed to view the full scale settings. Use the AIR▲ or (SHIFT)▼ buttons to scroll through screens showing the different settings.

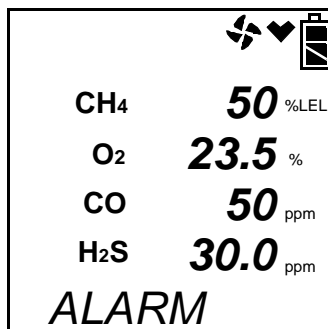
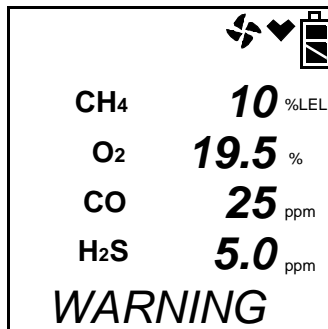
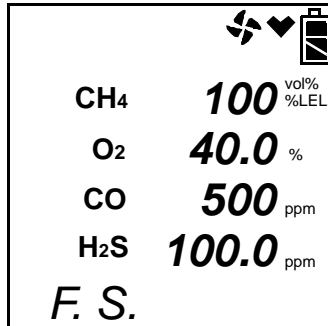

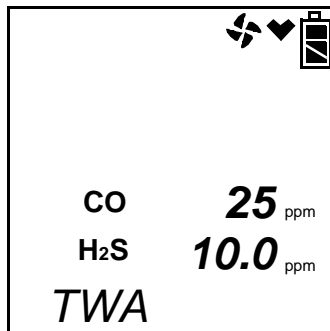
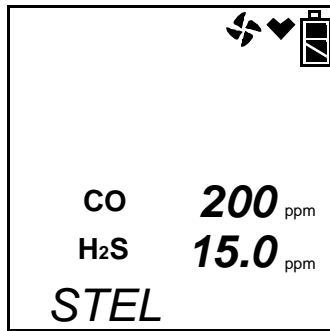

Pressing and releasing POWER ENTER while in a settings screen will cause the instrument to simulate that condition. The buzzer, LEDs, and vibration will activate. Press and release POWER ENTER again to stop the simulated alarm.

Operation Time Screen

The operation time screen displays the time in minutes since the GX-2012 was last turned on. The operation time may be continued from the last time the GX-2012 was in operation by using the lunch break option. See “Turning On the GX-2012, Normal Mode Only” on page 19.

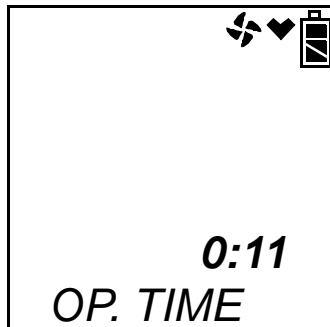

Date/Time Screen

The date/time screen displays the current date and time with the order being year, month, day, time.

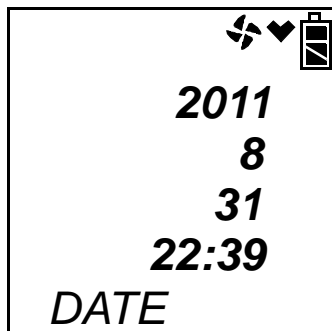

Remaining Log Time Screen

The remaining log time screen displays the time remaining until the data logger memory is full. The remaining log time depends on how often the GX-2012 stores data to the data log, how many channels are active, and how often the GX-2012 is turned on and off.

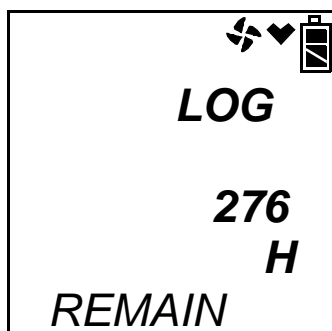

The table below illustrates how much data logging time is available for the various interval times. It assumes that the unit is set up with all 5 sensors, is only turned on once, and there are no alarm occurrences.

Table 6: Data Logging Capacity, 5 Sensor GX-2012

Interval Time	Data Logging Time
10 seconds	10 hours
20 seconds	20 hours
30 seconds	30 hours
1 minute	60 hours
3 minutes	180 hours
5 minutes	300 hours
10 minutes	600 hours

Clear Data Logger Screens

CAUTION: *Once you clear the data logger, you cannot retrieve any data previously stored in the data logger.*

NOTE: This item appears in Display Mode only if the **DLOG DSP** menu item in Maintenance Mode is turned ON. The factory setting for **DLOG DSP** is ON.

The clear data logger screens allow you to clear the data logger storage. You can set the GX-2012 to overwrite the oldest data when the data log is full. See “Updating the Datalog Overwrite Setting” on page 110. The bottom line of the screen alternates between LG CLEAR, NO /DISP, and YES/ENT.

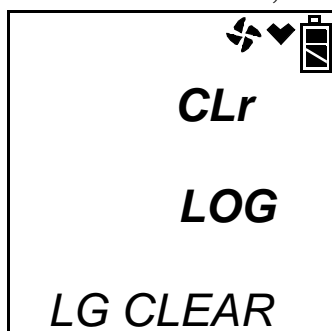

To clear the data log:

1. With the above screen displayed, press and release the POWER ENTER button. The instrument will ask you to confirm that you want to clear the data log and CLr LOG will be flashing. The bottom line of the screen alternates between CONFIRM?, YES/ENT., AND NO /DISP.

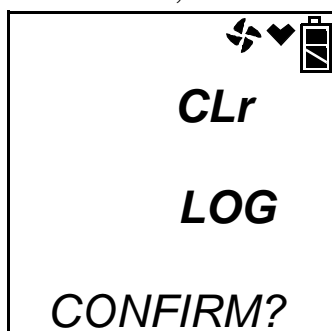

2. To cancel the clear data log and return to the Clear Data Logger Screen in Display Mode, press and release DISPLAY (ADJ).

To continue with the clear data log, press and release POWER ENTER.

3. The GX-2012 displays 4 dashes and as the GX-2012 clears the data, the dashes disappear. When the last dash is gone, the GX-2012 has been cleared and the remaining log time value is reset.

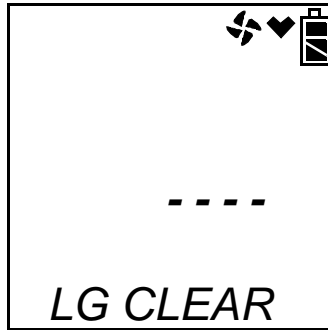

Pump OFF Screen

WARNING: *The GX-2012 is not a gas monitoring device while the pump is off.*

NOTE: This item appears in Display Mode only if the **POFF DSP** menu item in Maintenance Mode is turned ON. The factory setting for **POFF DSP** is OFF.

The GX-2012 pump can be turned on and off in this screen. The bottom line of this screen alternates between PUMP OFF, NO /DISP, and YES/ENT. This feature can be used to conserve battery life if there is a significant period of time until the next gas monitoring task, but you do not want to wait for the warmup sequence to complete if you turn the instrument off and on again.

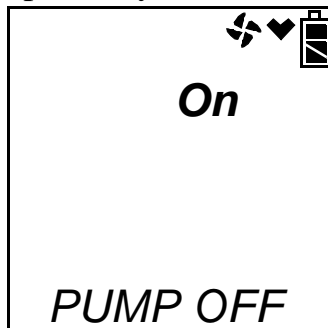

In this screen, press POWER ENTER to turn the pump off. The fan in the upper right corner of the screen will disappear. Once the pump is off, you cannot exit this screen and return to normal operation or continue in Display Mode until you turn the pump back on. To turn the pump back on and continue in Display Mode or return to Normal Operation, press the POWER ENTER button again.

User ID Screen

This screen displays only if **ID DISP** in the Maintenance Mode menu is set to ON (see “Turning the ID Display Function On or Off” on page 116). Each user ID can contain up to 16 characters but only the first 8 of those characters are visible in the instrument. Be sure that all user IDs are distinguishable from each other by viewing only the first 8 characters. For more information, see the GX-2012 Data Logger Management Program manual. The bottom line of the screen alternates between YES/ENT., the current user ID, and NO /DISP. Uppercase letters, numbers, asterisks (*), dashes (-), and a blank space are available characters. The GX-2012 can store 128 user IDs.

Use this screen to identify or change the user. The user ID provides a way to identify the user during a data logging session. The user ID is saved to the data logger for that session when you turn off the GX-2012 or change users during operation. This allows you to change the user ID during operation and have each user ID that was used during an operating session saved for the corresponding data.

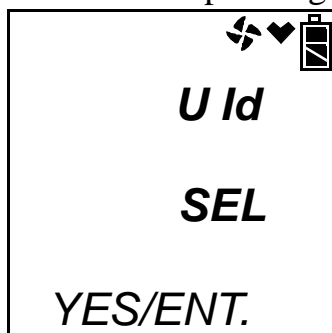

NOTE: As shipped from the factory, the user ID on this screen is shown as - - - - - until you enter this screen and select a user ID.

To change a user:

1. After entering Display Mode and proceeding to the User ID screen, press and release the POWER ENTER button. The bottom line of this screen alternates between YES/ENT., the current user ID, and NO /DISP.

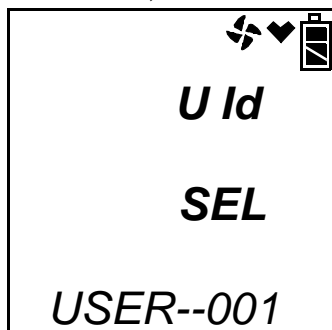

2. Use the AIR▲ and (SHIFT)▼ buttons to scroll through the 128 possible user IDs.
3. Press the POWER ENTER button to select a user ID.

Station ID Screen

This screen displays only if **ID DISP** in the Maintenance Mode menu is set to ON (see “Turning the ID Display Function On or Off” on page 116). Each station ID can contain up to 16 characters but only the first 8 of those characters are visible in the instrument. Be sure that all station IDs are distinguishable from each other by viewing only the first 8 characters. For more information, see the GX-2012 Data Logger Management Program manual. The bottom line of the screen alternates between YES/ENT., the current station ID, and NO /DISP. Uppercase letters, numbers, asterisks (*), dashes (-), and a blank space are available characters. The GX-2012 can store 128 station IDs.

Use this screen to identify or change the station. The station ID provides a way to identify the station during a data logging session. The station ID is saved to the data logger for that session when you turn off the GX-2012 or change stations during operation. This allows you to change the station ID during operation and have each station ID that was used during an operating session saved for the corresponding data.

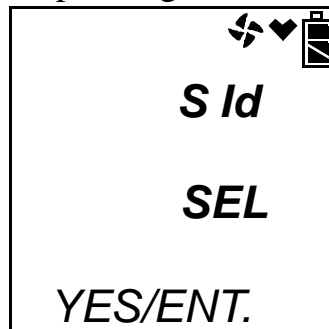

NOTE: As shipped from the factory, the station ID on this screen is shown as -- -- -- -- -- -- until you enter this screen and select a station ID.

To change a station:

1. After entering Display Mode and proceeding to the Station ID screen, press and hold the POWER ENTER button. The bottom line of this screen alternates between YES/ENT., the current station ID, and NO / DISP.

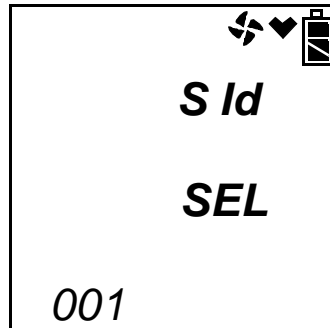

2. Use the AIR▲ and (SHIFT)▼ buttons to scroll through the 128 possible station IDs.
3. Press the POWER ENTER button to select a station ID.

Snap Logging Screen

The Snap Logging Screen allows you to view data from previous snap loggings. For information on how to use the snap logging feature, see “Snap Log Mode” on page 32.

1. To view snap logging data, use the AIR▲ and (SHIFT)▼ buttons to scroll to the Snap Logging Screen. The bottom line of this screen alternates between REC. DATA, NO /DISP, and YES/ENT.

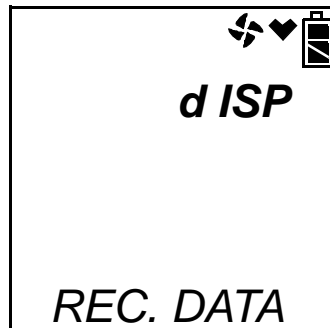

2. Press and release the POWER ENTER button. If no snap logs have been performed, the following screen will appear.

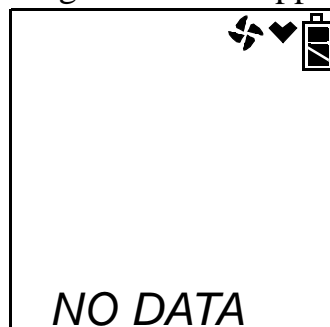

3. If snap logs have been performed, the following screen will appear.

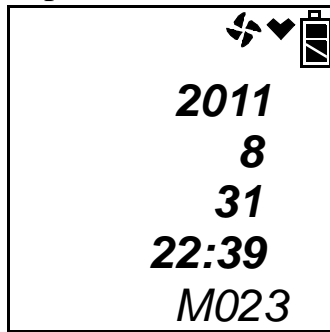

This screen indicates the year, month, day, and time that the most recent snap log was taken. The number along the bottom of the screen indicates the snap log ID number. The first snap log that is taken is given an ID of M001. The next snap log ID is M002. The ID number increases sequentially with each set of snap log data. Use the AIR▲ and (SHIFT)▼ buttons to scroll through different snap log IDs and view what time they were taken.

4. To view the data in a snap log ID, press and release the POWER ENTER button.

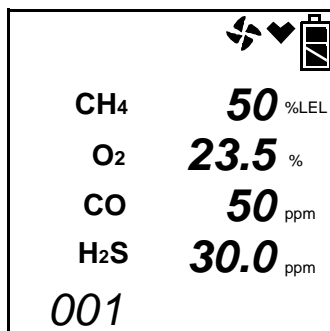

The gas readings that were taken during the snap log are displayed and the Station ID that was in use during the snap log is displayed along the bottom of the screen. You can use the AIR▲ and (SHIFT)▼ buttons to scroll through the different snap logs. The gas readings and station ID will change but the snap log ID is not visible from this screen. To scroll through the data by viewing the snap log ID number, press and release POWER ENTER.

Peak Bar Select Screen

The Peak Bar Select Screen allows you to turn the peak bar on or off. If the function is turned on, the peak bar appears along the left side of the screen during Normal Operation and on the Peak Screen in Display Mode. It shows the peak readings for each channel in bar graph format. The bottom line of this screen alternates between the current setting, NO /DISP, and YES/ENT.

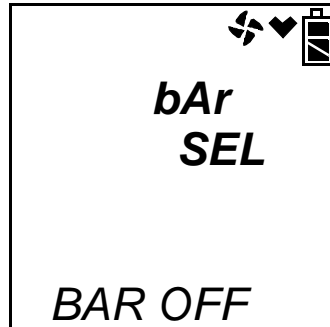

To adjust the peak bar selection:

1. Use the DISPLAY (ADJ) button to scroll to the Peak Bar Select Screen. The screen indicates the current setting.

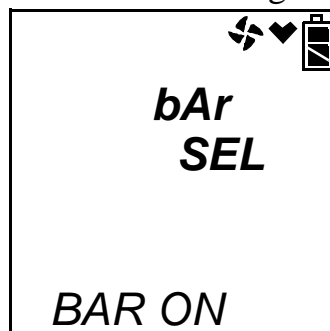

2. Press and release the POWER ENTER button.

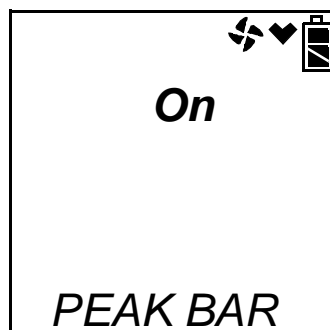

3. Use the AIR▲ and (SHIFT)▼ buttons to make your selection and press and release the POWER ENTER button.

Data Logging

NOTE: The GX-2012 logs data in both Normal Mode and Bar Hole Mode.

The GX-2012 features the ability to log data to its internal memory and download it to a computer via the infrared communications port located just below the RESET SILENCE button. It logs gas readings during normal operation, alarm data, and calibration data.

NOTE: The data logging function is separate from the snap logging function. For a description of the snap logging function, see “Snap Log Mode” on page 32.

To utilize the GX-2012’s downloading capability, you will need the GX-2012 downloading software and a computer with an infrared port or a USB port that runs one of the following operating systems: Windows XP, Windows Vista, or Windows 7. If your computer has an infrared port, then no additional accessories are needed to download data from the GX-2012. If your computer does not have an infrared port but does have a USB port, a USB/IrDA adapter cable can be used to download data from the GX-2012 using a USB port. The downloading software is available from RKI Instruments, Inc. The adapter cable is also available from RKI or may be purchased at a computer or electronics supply store.

For a complete description of the downloading software and procedures for downloading data to a computer, see the GX-2012 Data Logger Management Program Operator’s Manual.

SDM-2012

The GX-2012 can be used with the SDM-2012 if desired. The SDM-2012 can charge the instrument if the lithium ion battery pack is being used. It can also bump test, calibrate, and retrieve saved data. The SDM-2012 can be operated as a single, stand-alone unit or can be used with up to 9 other SDM-2012s and operated using a computer. For more information about the operation of the SDM-2012, see the SDM-2012 operator’s manual.

Calibration Mode

Calibration Mode allows you to calibrate the GX-2012's sensor response and to bump test the GX-2012.

CAUTION: BEFORE EACH DAY'S USAGE, SENSITIVITY IN THE % LEL RANGE MUST BE TESTED ON A KNOWN CONCENTRATION OF THE COMBUSTIBLE TARGET GAS, METHANE, EQUIVALENT TO 25 - 50% OF FULL SCALE CONCENTRATION (The % LEL full scale is 100% LEL). ACCURACY MUST BE WITHIN -0 to + 20% OF ACTUAL. ACCURACY MAY BE CORRECTED BY FOLLOWING THE CALIBRATION INSTRUCTIONS FOR THE COMBUSTIBLE CHANNEL BELOW.

If the combustible channel passes the above response test and does not require calibration, the unit should still be calibrated periodically. The optimum frequency of calibration depends heavily on how the GX-2012 is used. For example, instruments used daily may need to be calibrated weekly or monthly, while instruments that are used only a few times a year may need to be calibrated before each use. Typical calibration frequencies range from monthly to quarterly. Make sure to perform the combustible channel response test as described above and make sure to develop a calibration schedule tailored to your application that takes this test and required calibration resulting from this test into account.

You can program the GX-2012 to notify you when it is due for calibration. See "Updating the Calibration Reminder Setting" on page 111.

Calibration/Bump Test Supplies and Equipment

To calibrate or bump test the GX-2012, you will need:

- Known calibrating samples of the gases being detected. The combustible and toxic gas samples should have concentrations in approximately the middle of the range of detection. An oxygen-free source, such as 100% nitrogen is recommended for setting the oxygen zero when using single calibration.
- A demand-flow regulator to provide adequate sample gas flow
- Non-absorbent tubing

CAUTION: *If you are using a calibration kit that includes a gas bag and a fixed flow regulator or dispensing valve, do not apply gas directly to the GX-2012 with the regulator or valve or damage to the pump will result. See “Appendix A: Calibrating and Bump Testing with a Sample Bag” on page 141 for instructions to properly use a gas bag kit.*

To calibrate or bump test the %LEL, Oxygen, CO, and H₂S sensors at the same time, automatically, with no need for a zero-oxygen source, you can use the auto calibration feature with a 4-gas cylinder. If the H₂S channel is not active, then a 3-gas cylinder may be used for auto-calibration. This section includes instructions for auto calibration and bump testing with a demand-flow regulator, a 4-gas cylinder, and a %volume methane cylinder. This section also includes instructions for calibrating one channel at a time using single calibration.

Preparing for Calibration or Bump Testing

Whether you will calibrate the GX-2012 using auto calibration, single calibration, or perform a bump test, you will need to set the fresh air readings first.

1. Find a fresh-air environment. This is an environment free of toxic or combustible gases and of normal oxygen content (20.9%).
2. Turn on the unit as described in “Turning On the GX-2012, Normal Mode Only” on page 19 or in “Turning On the GX-2012 in Normal Mode With All Modes Active” on page 25. Use the sample hose and probe.
3. With the unit on, perform a fresh air adjustment by pressing and holding the AIR▲ button. The display prompts you to hold the AIR▲ button.
4. Continue to hold the AIR▲ button until the display prompts you to release it. The GX-2012 will set the fresh air reading for all channels as it counts down from 8. If the combustible channel is set as %LEL only or vol% only, there is no countdown period. The fresh air reading is set immediately.
5. Install the demand flow regulator onto the calibration cylinder.
6. Connect the sample tubing to the demand flow regulator.

Calibrating the GX-2012

From Measuring Mode, enter Calibration Mode by pressing and holding the (SHIFT)▼ button, then pressing the DISPLAY(ADJ) button and releasing both. If the unit prompts you for the password, enter it by using the AIR▲ and (SHIFT)▼ buttons to select each password number and then pressing and releasing POWER ENTER to confirm it and move on to the next number.

The factory set password is the same as the factory set password for Maintenance Mode: 2102. You can change the password by entering the **PASSWORD** menu item in Maintenance Mode. See “Turning the Password Function On or Off” on page 120. If you enter an incorrect password, an error screen will display.

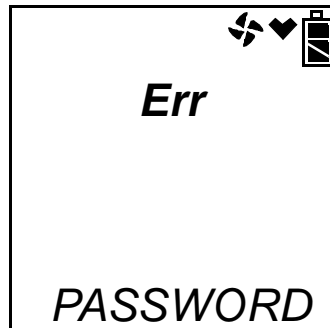

To return to normal operation, press and release the RESET SILENCE button. You may then try to reenter Calibration Mode.

MAINTENANCE will appear along the top of the screen once you have entered Calibration Mode. The first item in the calibration menu, AIR CAL, displays.

NOTE: The following screens illustrate a four-gas GX-2012 with both a %LEL and a % volume combustible gas sensor as examples only. Your GX-2012 may display slightly different screens.



The GX-2012’s calibration menu includes two methods of calibration: auto calibration and single calibration.

- **Auto Calibration:** This method allows you to calibrate the combustible gas (%LEL sensor only), OXY, H₂S, and CO sensors simultaneously. It is designed for use with the RKI 4-gas calibration cylinder and is the quickest and easiest method to calibrate the GX-2012. If installed, you may also calibrate the %volume sensor separately from the standard four.
- **Single Calibration:** This method allows you to calibrate one sensor at a time. Use this method if you are only calibrating one or two sensors, if you are calibrating only the %volume combustible sensor, or if you are

not using the RKI 4-gas calibration cylinder.

Calibrating with the Auto Calibration Method

This section describes calibration using the auto calibration method.

To calibrate using the single calibration method, see “Calibrating with the Single Calibration Method” on page 62. These instructions assume you are using a 4-gas cylinder and a % volume methane cylinder.

1. You may only calibrate either the standard 4 sensors or the % volume combustible sensor at a time. Once you are finished, you are returned to the initial AUTO CAL screen and must begin the auto calibration process again.
2. Use the AIR▲ and (SHIFT)▼ buttons to display the **AUTO CAL** menu item, press and release the POWER ENTER button to display the calibration values screen. If you want to exit back to the main menu without completing a calibration, press and release the DISPLAY (ADJ) button.
3. Use the AIR▲ or (SHIFT)▼ button to alternate between the 4-gas and the % volume combustible gas calibration values screens.

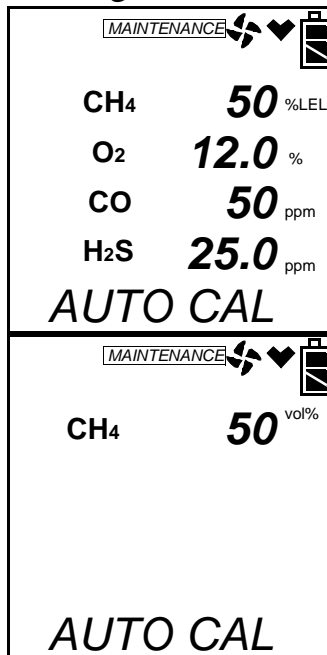

4. The gas concentrations displayed in the calibration values screens must match the gas concentrations listed on the calibration cylinders. If *all* concentrations match, go to step 12. If *one or more* concentrations do not match, continue with step 5.

5. To adjust the values on the screens, hold down the (SHIFT)▼ button, then press the DISPLAY(ADJ) button and release both. The %LEL sensor is shown here.

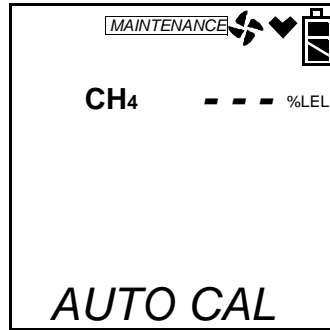

6. Use the AIR▲ and (SHIFT)▼ buttons to scroll through the sensors and select the sensor whose calibration gas value you want to adjust.
7. Press and release the POWER ENTER button. The sensor's calibration gas value will flash.
8. If necessary, use the AIR▲ and (SHIFT)▼ buttons to set the correct calibration gas value.
9. Press and release POWER ENTER button to save the change.
10. Repeat steps 6 through 9 to set the correct values for any additional sensors.
11. After the last calibration gas value is set, use the AIR▲ button to scroll to ESCAPE and press POWER ENTER to return to the calibration gas values screens.

NOTE: The RKI Four Gas Cylinder typically contains 12% O₂ by volume. Be sure to set the "OXY" reading to agree with the concentration listed on the cylinder's label, not zero.

12. Use the AIR▲ or (SHIFT)▼ button to select which sensor(s) you want to calibrate, the standard 4 sensors or the %volume combustible gas sensor. The following instructions illustrate calibrating the standard 4 sensors first, then the %volume combustible gas sensor.

13. With the 4-gas calibration values screen displayed, press the POWER ENTER button. AUTO CAL begins to flash and the current gas readings are displayed. If you want to exit back to the main menu without completing a calibration, press and release the DISPLAY (ADJ) button.

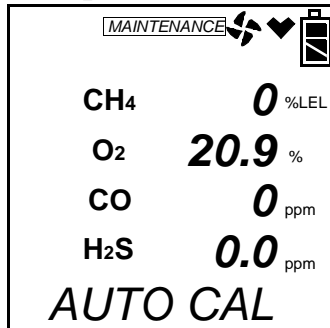

14. Connect the tubing from the demand flow regulator to the rigid tube on the probe. Allow the gas to flow for one minute.
15. Press and release the POWER ENTER button to set the calibration to the programmed values.

If all channels passed calibration, PASS displays along the bottom of the screen, then the calibration menu displays.

If any of the sensors cannot calibrate to the proper value, FAIL displays along the bottom of the screen and the GX-2012 lists the sensor(s) that failed to calibrate. In the example below, the OXY and H₂S channels failed calibration. The other sensors calibrated normally.

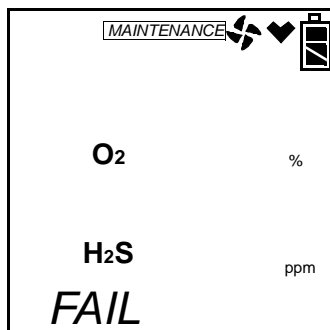

The buzzer and alarm lights activate. Press and release the RESET SILENCE button after the buzzer and lights stop to reset the alarm and return to the calibration menu. Attempt to calibrate again. If the failure continues, investigate the cause. See “Troubleshooting” on page 123.

16. Disconnect the tubing from the probe.
17. Unscrew the demand flow regulator from the calibration cylinder.
18. If you have a 5 sensor unit and wish to calibrate the % volume combustible gas sensor, go back to step 1 and repeat the process selecting the % volume calibration gas value screen in step 12 and using a

% volume methane cylinder.

If you are finished calibrating, use the (SHIFT)▼ button to navigate to the **NORMAL** menu item, then press and release the POWER ENTER button to return to Measuring Mode.

Calibrating with the Single Calibration Method

This section describes calibration using the Single Calibration method. To calibrate using the Auto Calibration method, see “Calibrating with the Auto Calibration Method” on page 59.

CAUTION: *The single calibration method does not have a “FAIL” notification. If a sensor cannot be set to agree with the calibration source, see “Troubleshooting” on page 123.*

1. While in the calibration menu, use the AIR▲ or (SHIFT)▼ button to navigate to the ONE CAL menu option.

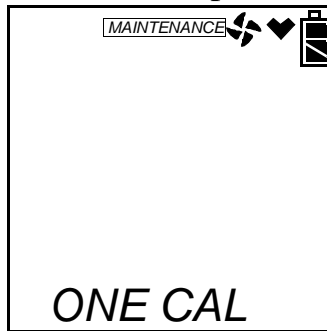

2. Press and release the POWER ENTER button to display the single calibration menu. The %LEL sensor will be displayed first.

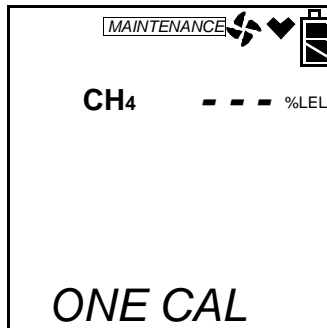

3. Use the AIR▲ or (SHIFT)▼ button to display the sensor you want to calibrate (in this example the combustible gas % LEL sensor). If you have a 5 sensor unit, the % vol sensor will be one of the choices. It is shown below.

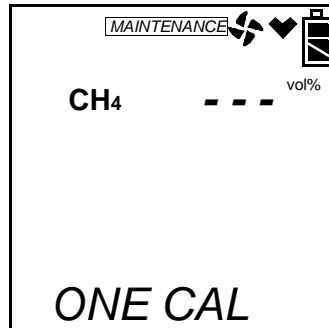

4. Press and release the POWER ENTER button. The single calibration screen displays for the sensor you selected. The gas reading flashes.

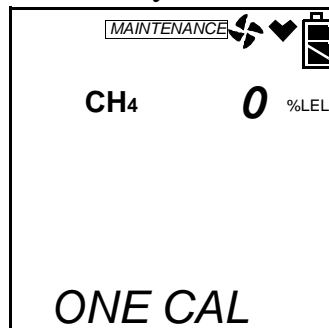

5. Connect the tubing from the demand flow regulator to the rigid tube on the probe. Allow the calibration gas to flow for one minute.
6. If necessary, use the AIR▲ and (SHIFT)▼ buttons to adjust the reading to match the concentration listed on the calibration cylinder.
7. Press and release the POWER ENTER button to save the span value. The LCD will indicate that the calibration has ended, then the single calibration menu displays.

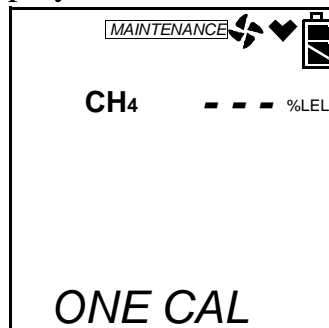

8. Disconnect the tubing from the probe.
9. Repeat steps 3 through 8 for any other sensors you want to calibrate. Make sure you use an appropriate calibration cylinder for each sensor.

CAUTION: *When calibrating the oxygen channel, verify the concentration of oxygen listed on the cylinder's label. For oxygen-free samples (100% nitrogen for example), set the oxygen zero setting to 0.0%.*

10. After the last channel is calibrated, disconnect the calibration tubing from the probe, then unscrew the demand flow regulator from the calibration cylinder.
11. Use the AIR▲ and (SHIFT)▼ buttons to scroll to ESCAPE in the ONE CAL menu.
12. Press and release the POWER ENTER button to exit ONE CAL.
13. With the ONE CAL menu option displayed, press the (SHIFT)▼ button until the **NORMAL** menu option is displayed.
14. Press and release the POWER ENTER button to return to Measuring Mode.

Bump Testing the GX-2012

NOTE: The **BUMP DSP** menu item in Maintenance Mode is factory set to OFF. The **BUMP** menu item will not appear unless **BUMP DSP** is set to ON. See “Turning the Bump Test Function On or Off” on page 106 for instructions.

NOTE: The GX-2012 uses parameters defined in the **BUMP--SET** menu item of Maintenance Mode while performing a bump test. To view or update these parameters, see “Updating the Bump Test Parameters” on page 108.

From Measuring Mode, enter Calibration Mode by pressing and holding the (SHIFT)▼ button, then pressing the DISPLAY(ADJ) button and releasing both. If the unit prompts you for the password, enter it by using the AIR▲ and (SHIFT)▼ buttons to select each password number and then pressing and releasing POWER ENTER to confirm it and move on to the next number. The factory set password is the same as the factory set password for Maintenance Mode: 2102. You can change the password by entering the **PASSWORD** menu item in Maintenance Mode. See “Turning the Password Function On or Off” on page 120. If you enter an incorrect password, an error screen will display.

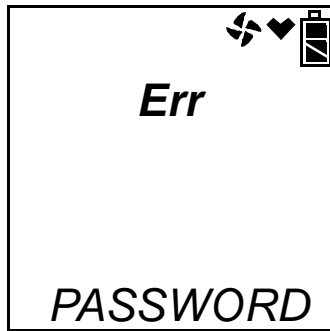

To return to normal operation, press and release the RESET SILENCE button. You may then try to reenter Calibration Mode.

MAINTENANCE will appear along the top of the screen once you have entered Calibration Mode. The first item in the calibration menu, AIR CAL, displays.

1. Install the demand flow regulator onto the calibration cylinder.
2. Connect the sample tubing to the demand flow regulator.
3. Install the hose and probe to the GX-2012.
4. Use the AIR▲ or (SHIFT)▼ buttons to display the BUMP menu item.

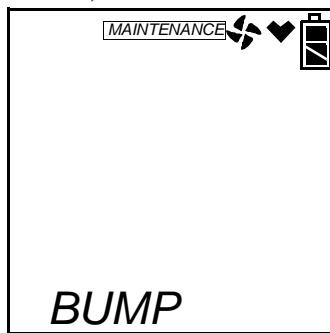

5. Press and release the POWER ENTER button to display the bump test gas values.

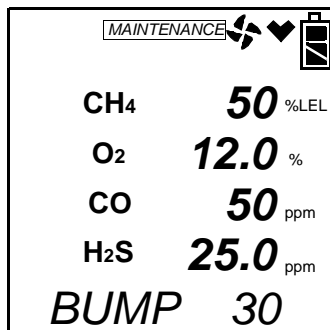

- Use the AIR▲ or (SHIFT)▼ buttons to see the %volume combustible gas bump test value.

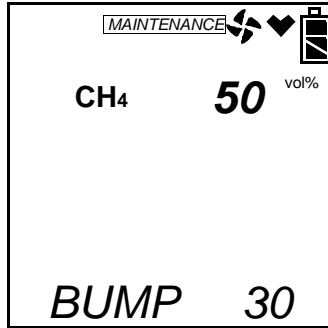

- A bump test may be performed on the standard 4 sensors or on the %volume combustible sensor. Use the AIR▲ or (SHIFT)▼ buttons to display the screen for the sensor(s) you wish to bump test.
- Before proceeding, confirm that the bump test gas value(s) are the same as the concentration(s) in the calibration cylinder. If they are not, adjust the bump test gas value(s) by entering the AUTO CAL menu item, changing the values there, and reentering the BUMP menu.
- Connect the tubing from the demand flow regulator to the rigid tube on the probe then quickly press and release the POWER ENTER button. The unit will begin counting down from 30.
- When AUTO CAL in the **BUMP--SET** menu item in Maintenance Mode is set to OFF:
 - The instrument will indicate which channels passed or failed the bump test with a P (pass) or an F (fail) to the right of the gas.

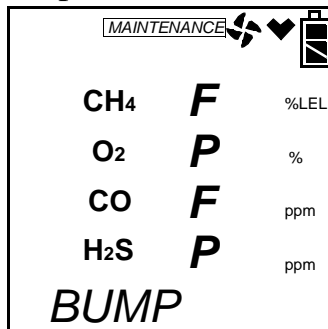

- To view the bump test gas readings press the AIR▲ or (SHIFT)▼ button. You can scroll between the bump test results and the bump test gas readings with the AIR▲ or (SHIFT)▼ button.

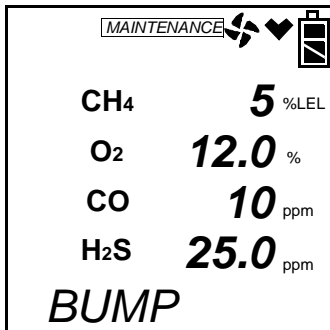

- To return to the BUMP screen in Calibration Mode, press POWER ENTER.

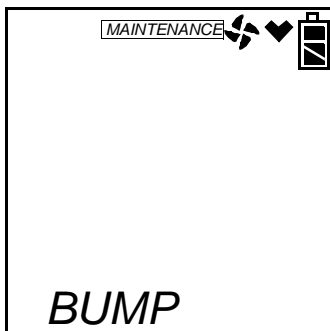

If one or more sensors fail the bump test, see “Troubleshooting” on page 123 to investigate the cause of the failure and replace the failed sensor or sensors if necessary.

- Disconnect the tubing from the probe.

11. When AUTO CAL in the **BUMP--SET** menu item in Maintenance Mode is set to ON:

If all channels pass the bump test,

- The following screen appears:

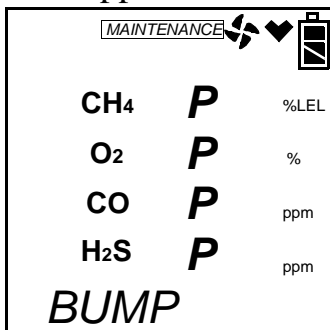

- To view the bump test gas readings press the AIR▲ or (SHIFT)▼ button. You can scroll between the bump test results and the bump test gas readings with the AIR▲ or (SHIFT)▼ buttons.

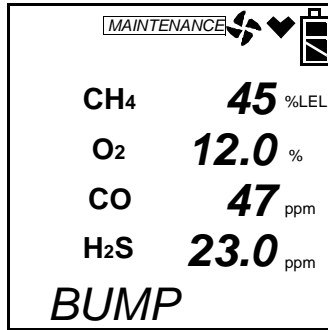

- To return to the BUMP screen in Calibration Mode, press POWER ENTER.

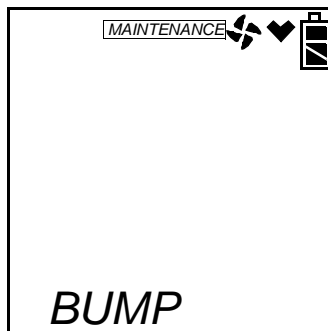

- Disconnect the tubing from the probe.

If any channel fails the bump test,

- The instrument will beep and a calibration is immediately and automatically started. Continue to apply the calibration gas. CAL on the bottom left of the screen will alternate with APPLY.

The calibration time will begin to countdown in seconds in the lower right of the screen. The calibration time counted down during a calibration initiated because of a failed bump test is the difference between the bump test gas time and the calibration time defined in the **BUMP--SET** menu item in Maintenance Mode.

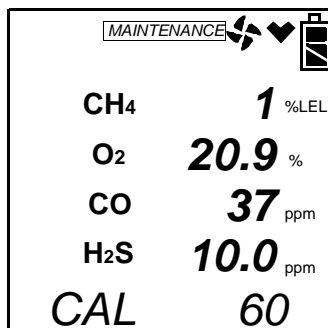

- At the end of the calibration, the instrument displays the results from both the bump test and the calibration. Use the AIR▲ or (SHIFT)▼ button to scroll between the calibration/bump test results, the bump test gas readings, and the calibration gas readings.

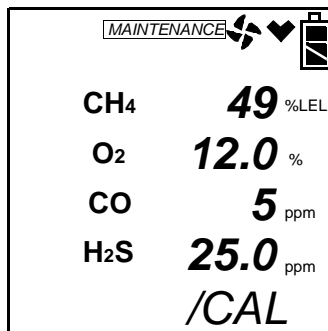
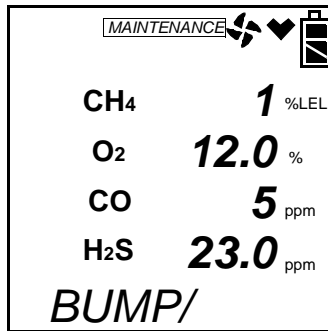
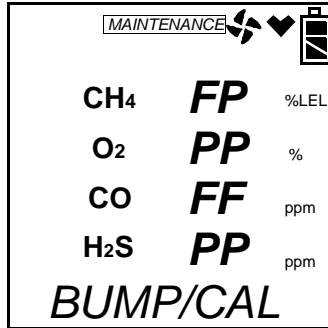

- To return to the **BUMP** screen in Calibration Mode, press **POWER ENTER** at any time. If any channel failed the calibration, the buzzer will sound a double pulsing tone until you press and release the **POWER ENTER** button.

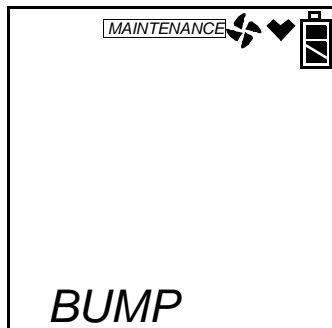

- Disconnect the tubing from the probe.
12. Unscrew the demand flow regulator from the calibration cylinder.
 13. With the **BUMP** menu option displayed, press the (SHIFT) ▼ button until the **NORMAL** menu option is displayed.
 14. Press and release the **POWER ENTER** button to return to Measuring Mode.

Chapter 4: Using the GX-2012 in Bar Hole Mode

Overview

This chapter explains how to operate the GX-2012 in Bar Hole Mode. Bar Hole Mode is used to perform consistent checks of bar holes when tracking down underground gas leaks. When the GX-2012 is in Bar Hole Mode, only the combustible and oxygen channels are displayed.

If a GX-2012 is intended for bar hole testing, it is shipped with Bar Hole Mode enabled so that the operator must choose which operational mode to use when the unit is turned on.

NOTE: Units intended for bar hole testing are typically calibrated to methane. In addition, the unit must have a % volume combustible sensor installed.

Start Up, Bar Hole Mode

This section explains how to start up the GX-2012 in Bar Hole Mode and get it ready for operation.

Turning On the GX-2012, Bar Hole Mode

WARNING: *If a CO or H₂S sensor is installed, these sensors will not be active while the GX-2012 is in Bar Hole Mode.*

WARNING: *Gas alarms are not active when the GX-2012 is in Bar Hole Mode.*

The following description of the GX-2012 start up sequence assumes that the following menu items in Maintenance Mode are turned on: **LNCH BRK**, **ID DISP**, **CL RMNDR**, and **BP RMNDR**. If either of these items is turned off, then the corresponding screen will not appear.

NOTE: In order for **BAR HOLE MODE** to appear as a selection in the Mode Select Screen in Step 3 below, the **L./B. MODE** menu item in Maintenance Mode must be set to bH.

1. Connect the sample hose to the GX-2012's quick connect inlet fitting.
2. Screw the bar hole probe onto the sample hose's threaded fitting.

3. Press and briefly hold down the POWER ENTER button. The Normal Mode Select Screen displays.

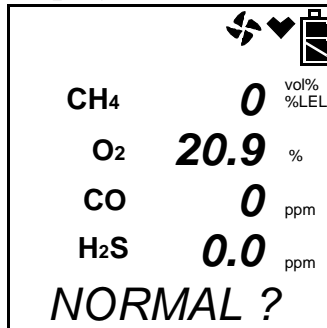

4. Use the AIR▲ or (SHIFT)▼ buttons to scroll to the Bar Hole Mode Select Screen.

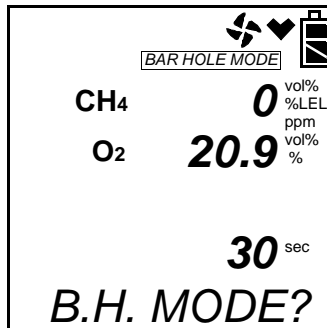

5. With the Bar Hole Mode Select Screen displayed, press and release the POWER ENTER button to begin the Bar Hole Mode startup sequence.

NOTE: If no button is pressed for 20 seconds, the unit will proceed into whichever mode is displayed.

6. If **CL RMNDR** is turned on (factory setting), the screen that appears next depends on how **CL EXPRD** is set in the Maintenance Mode Menu (page 111).
 - If the unit is due for calibration and **CL EXPRD** is set to CONFIRM (factory setting), then the following screen displays.

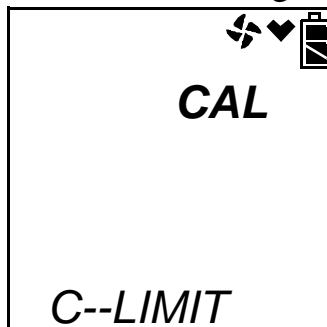

The alarm LED's and buzzer will pulse several times. After this, press and release the RESET SILENCE button to continue.

- If the unit is due for calibration and **CL EXPRD** is set to NOT USE, then the following screen displays.

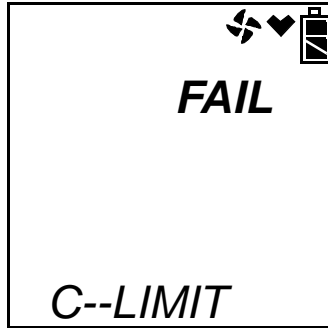

The GX-2012 cannot be used until a calibration has been performed either by selecting **AUTO CAL** or **ONE CAL** in the Maintenance Mode menu. See “Calibrating Using Auto Calibration” on page 86 or “Calibrating Using Single Calibration” on page 90 for calibration instructions.

- If calibration is not due or **CL EXPRD** is set to NO EFFECT, then the following screen appears for a few seconds indicating when the next calibration is due.

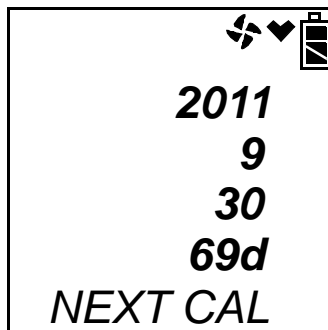

7. If **BP RMNDR** is turned on (factory setting is OFF), the screen that appears next depends on how **BP EXPRD** is set in the Maintenance Mode Menu (page 112).

- If the unit is due for a bump test and **BP EXPRD** is set to CONFIRM (factory setting), then the following screen displays.

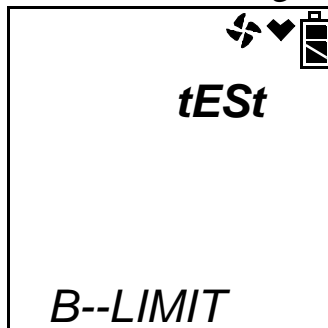

The alarm LED's and buzzer will pulse several times. After this, press the RESET SILENCE button until you hear a beep to continue.

- If the unit is due for a bump test and **BP EXPRD** is set to NOT USE, then the following screen displays.

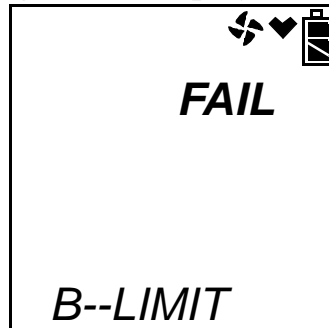

The GX-2012 cannot be used until a bump test has been performed by selecting **BUMP** in the Maintenance Mode menu. See “Performing a Bump Test” on page 92 for bump testing instructions.

- If a bump test is not due or **BP EXPRD** is set to NO EFFECT, then the following screen appears for a few seconds indicating when the next bump test is due.

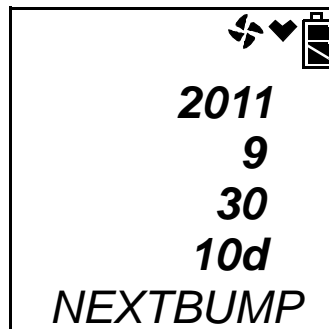

NOTE: If both **CL RMNDR** and **BP RMNDR** are turned off, a WARM UP screen will display before the warm up sequence continues.

8. If **ID DISP** is turned on (see page 116), the User ID Screen displays for a few seconds and then the Station ID Screen displays for a few seconds.

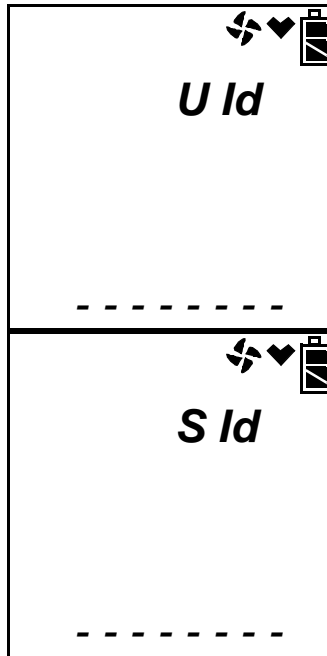

9. The Date/Time Screen appears for a few seconds.

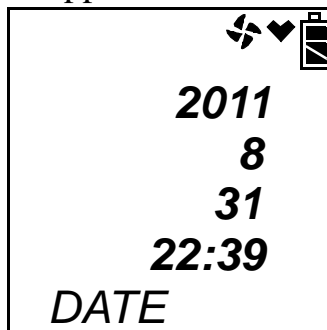

This screen displays the current year, month, date, and time.

10. The Battery Level and Alarm Pattern Screen appears next.

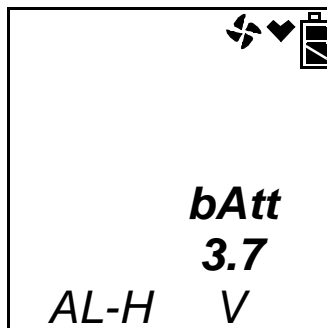

AL -- H indicates latching (hold) alarms and AL -- A indicates self-resetting (automatic) alarms. The number shown indicates the voltage of the batteries. A fully charged lithium ion battery pack will display 3.7 V. If the unit is powered by alkaline (dry cell) batteries, a “D” will appear in front of the “V” in the lower right corner.

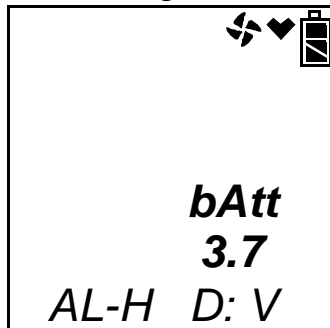

11. The display then indicates the following items for about a second each:
 - Full scale values for all channels
 - Warning setpoint (low gas alarm) for all channels
 - Alarm setpoint (high gas alarm) for all channels
 - STEL alarm setpoint for the CO and H₂S channels
 - TWA alarm setpoint for the CO and H₂S channels
12. If the GX-2012 experiences a sensor failure during start up, a screen indicating which sensor failed displays. In the example below, the combustible gas %volume sensor has failed.

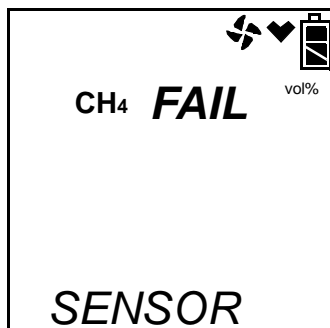

If one of the combustible sensors, LEL or % volume, fails, it is not possible to enter Bar Hole Mode. Press and release the RESET SILENCE button to acknowledge the failure and return to the Mode Select Screen. Replace the failed sensor as soon as possible.

If the oxygen sensor fails, press and release the RESET SILENCE button to acknowledge the failure and continue to Bar Hole Mode. The gas reading for the oxygen sensor will be replaced by “XXX”. Replace the failed sensor as soon as possible.

If the CO or H₂S sensor is installed and fails, press and release the RESET SILENCE button to acknowledge the failure and continue to Bar Hole Mode.

13. The GX-2012 is now operating in Bar Hole Mode. The pump is off and the following screen appears.

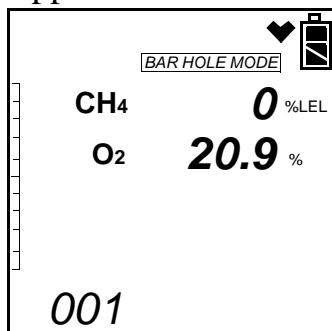

The methane and oxygen channels are displayed along with the battery charge level.

Performing a Fresh Air Adjustment, Bar Hole Mode

Before using the GX-2012, it is recommended to set the fresh air readings for the target gases by performing a fresh air adjustment. This will set the combustible gas channel to zero and the OXY channel to 20.9%.

1. Find a fresh-air environment. This is an environment free of toxic or combustible gases and of normal oxygen content (20.9%).
2. Turn on the unit as described above in “Turning On the GX-2012, Bar Hole Mode”.
3. Press and hold the AIR▲ button. The pump will start and the display will prompt you to hold the AIR▲ button.
4. Continue to hold the AIR▲ button until the display prompts you to release the AIR▲ button. The GX-2012 will set the fresh air reading for the CH₄ and oxygen channels as it counts down from 8. Once the countdown has finished, start up is complete and the unit is ready for bar hole testing.

Bar Hole Testing

In Bar Hole Mode, the you can initiate sampling for a fixed time period to monitor for methane and oxygen in a bar hole. The factory set time is 30 seconds. To change the bar hole sampling time, see “Updating the Bar Hole Sampling Time” on page 119. At the end of the sample period, the pump will shut off and the peak methane and minimum oxygen levels monitored during the sample period will be displayed. Bar Hole Mode also allows you to initiate an air purge cycle to purge gas from the GX-2012 after a sample is taken.

In a low-light environment, press and release the (SHIFT)▼ button to turn on the display backlight. Although the backlight will turn on when any button is pressed, other buttons may initiate an undesired operation sequence. See “Updating the LCD Back Light Time Setting” on page 116 to program backlight duration. If **BEEP. SET** is turned on in the Maintenance Mode menu, the GX-2012 beeps once every 5 minutes to confirm that it’s operating.

While in Bar Hole Mode, you may select or change the current station ID by pressing the (SHIFT)▼ button and DISPLAY (ADJ) button and releasing when you hear a beep.

Performing a Bar Hole Test

1. Start up the GX-2012 as described in “Start Up, Bar Hole Mode” on page 71.
2. If you wish to change the station ID, press the (SHIFT)▼ and DISPLAY (ADJ) buttons and release when you hear a beep. The current station ID will be displayed and it will be flashing. If you wish to exit the Station ID Select Screen without making any changes, press and release the RESET SILENCE button.

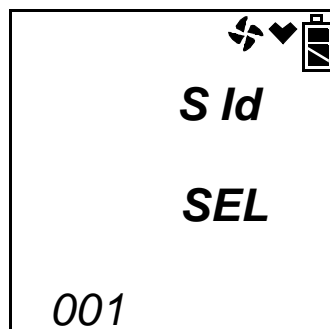

Use the AIR▲ and (SHIFT)▼ buttons to scroll to the desired station ID and press and release POWER ENTER. The unit will return to the Bar Hole Measuring Screen.

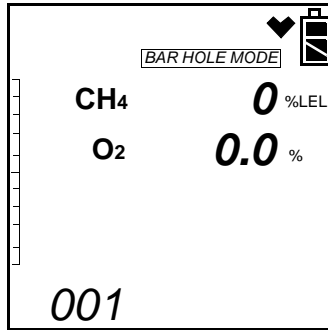

3. Take the GX-2012 to the bar hole that will be tested.
4. Insert the probe into the bar hole and press and release the POWER ENTER button. The pump will turn on and the sample period will begin with the sample period counting down in seconds in the lower right corner of the display. The CH₄ channel will be displayed in %VOL. The methane channel's reading will also be displayed in graph format on the left side of the screen. If you wish to cancel the measurement, press and release the RESET SILENCE button.

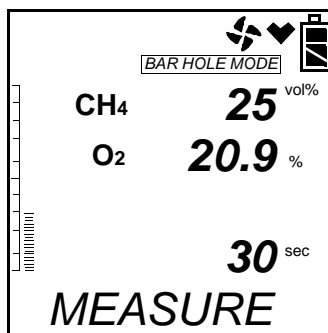

5. After 15 seconds of sampling, if the combustible gas reading is less than 5 %VOL, the combustible gas channel will automatically begin displaying in %LEL.

6. At the end of the sample period, the pump will shut off and the buzzer will sound, then the peak methane reading and the minimum oxygen reading for the sample period will be displayed. The peak methane reading will also be visually displayed on the graph along the left side of the screen.

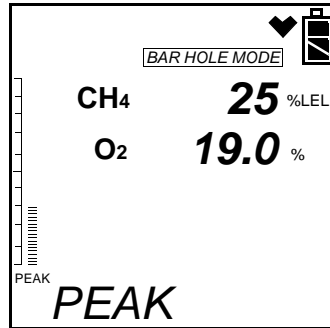

7. If a high concentration of methane is encountered, a fresh air purge can be performed to purge the hose, probe and GX-2012 of gas before the next bar hole test. To perform a purge, do the following:
- Remove the probe from the barhole so the instrument will draw fresh air.
 - Press and release the DISPLAY (ADJ) button. The display will now indicate PURGE along the bottom of the screen and the purge time will begin counting down from 30 seconds in the lower right corner of the display. If you wish to cancel the purge, press and release the RESET SILENCE button.

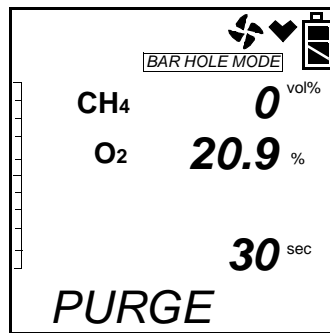

- When the purge is complete, the screen will return to the initial Bar Hole Mode screen.

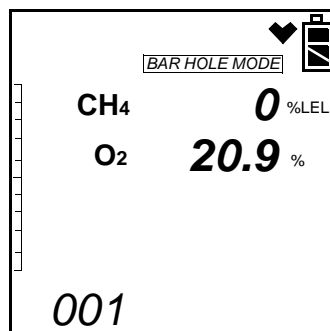

8. If other bar holes will be tested, proceed to the next bar hole and repeat steps 4 - 7.
9. To cancel a bar hole measurement or fresh air purge that is in progress, press and release the RESET SILENCE button.
10. To exit Bar Hole Mode and return to the Mode Select Screen at any time, press and hold the (SHIFT)▼ button for 5 seconds.

Turning Off the GX-2012, Bar Hole Mode

1. Press and hold the POWER ENTER button.
2. The unit will initiate a bar hole measurement. Keep holding the POWER ENTER button. The buzzer will pulse for about three seconds and TURN OFF will appear at the bottom of the screen.
3. Release the button when TURN OFF disappears.

Chapter 5: Maintenance Mode

Overview

This chapter describes the GX-2012 in Maintenance Mode. In Maintenance Mode, you can:

- update the date and time
- perform a fresh air adjust
- perform an auto calibration
- perform a single calibration
- perform a bump test
- turn the lunch break setting on or off
- update the alarm latching setting
- turn alarm silencing on or off
- update the interval trend time setting
- update warning, alarm, STEL, and TWA settings
- turn the clear data logger screen on or off
- turn the bump test function on or off
- turn the pump off screen on or off
- update bump test parameters
- update the confirmation beep setting
- update the data logger overwrite setting
- update the calibration interval setting
- turn the calibration reminder function on or off
- update the calibration expired action setting
- update the calibration check setting
- update the bump test interval setting
- turn the bump test reminder function on or off
- update the bump test expired action setting
- update the bump test check setting
- turn the ID display function on or off

- update the backlight settings
- turn the autozero function on or off
- turn the demand zero function on or off
- update the Leak Check/Bar Hole Mode setting
- update the bar hole sampling time
- view the instrument's firmware version and checksum information
- turn the password function on or off and set the password

The GX-2012 is factory-set to suit most applications. Update settings in Maintenance Mode only if required for your specific application.

Tips for Using Maintenance Mode

- Use (SHIFT)▼ to scroll down through the main menu and submenus, and to lower values or change the setting in a specific option.
- Use AIR▲ to scroll up through the main menu and submenus, and to raise values or change the setting in a specific option.
- Use the POWER ENTER button to enter a selected menu item, and to enter and save settings that have been updated.
- An adjustable parameter that is flashing can be adjusted with the AIR▲ and (SHIFT)▼ buttons.
- Press the DISPLAY (ADJ) button while entering or updating parameters to exit the screen without saving any changes.

Using Maintenance Mode

WARNING: *The GX-2012 is not in operation as a gas detector while in Maintenance Mode. Although it will respond to gas in parts of AUTO CAL and ONE CAL, there are no alarm indications.*

1. Take the GX-2012 to a non-hazardous location, and turn it off if it is on.

2. Press and hold the AIR▲ and (SHIFT)▼ buttons, then press and hold the POWER ENTER button. When you hear a beep, release the buttons. The

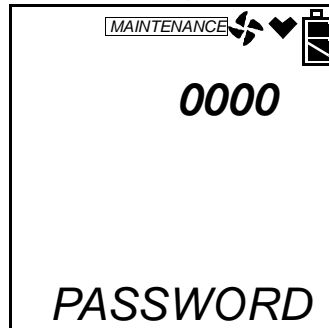

unit will prompt you for a password.

3. Enter the password by using the AIR▲ and (SHIFT)▼ buttons to select each password number and then pressing and releasing POWER ENTER to enter it and move on to the next one.

NOTE: A password is always needed to enter Maintenance Mode even if the **PASSWORD** menu item in Maintenance Mode has been turned off (factory setting). The factory set password is 2102. You may change this password by entering the **PASSWORD** menu item in Maintenance Mode.

4. If you enter an incorrect password, an error screen will appear.

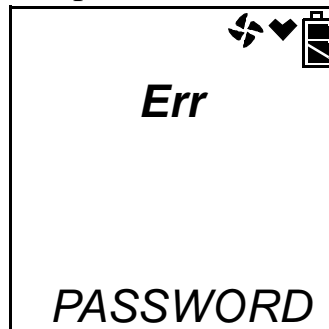

You must turn the unit off and reenter Maintenance Mode using the correct password.

5. Once you enter Maintenance Mode, MAINTENANCE will appear along the top of the screen. The Date Screen displays.

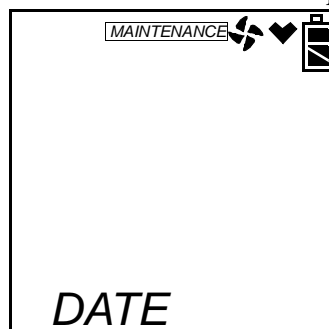

6. Use the AIR▲ or (SHIFT)▼ button to move through the menu item screens.

Updating the Date and Time Settings

1. Use the AIR▲ or (SHIFT)▼ buttons to display the **DATE** menu item.

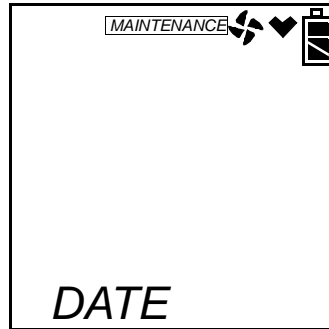

Press and release the POWER ENTER button. The date and time will be displayed with the year flashing.

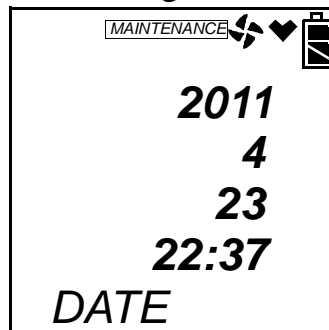

2. Use the AIR▲ or (SHIFT)▼ button to display the desired year.
3. Press and release the POWER ENTER button to save the setting. The month setting flashes.
4. Repeat steps 2 and 3 to enter the month, day, hours, and minutes settings. The Date menu item displays after you enter the minutes setting.

Performing a Fresh Air Adjustment

1. Confirm you are in a fresh air environment that is free of toxic and combustible gases and of normal oxygen concentration, 20.9%.
2. Use the AIR▲ or (SHIFT)▼ buttons to navigate to the **AIR CAL** menu option.

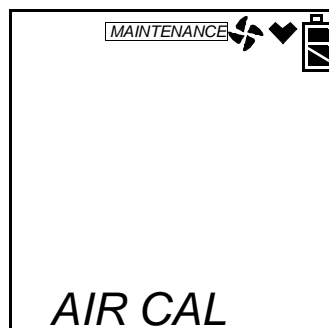

3. Press and release the POWER ENTER button to enter **AIR CAL**. The current gas readings are displayed.

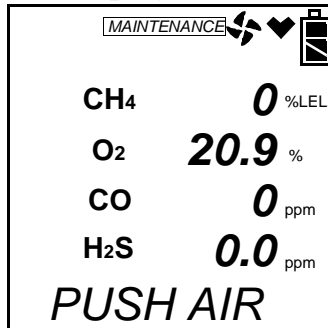

4. Hold down the AIR▲ button. The unit will prompt you to continue holding the AIR▲ button.

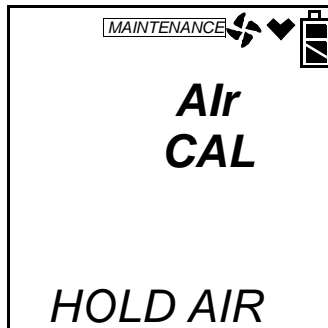

5. When the unit tells you to release the AIR▲ button, release it. The unit will count down from 8 as it performs the fresh air adjust.

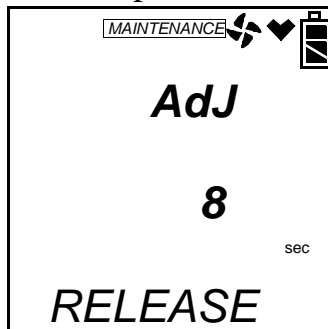

Once it has finished, it will return to the **AIR CAL** menu screen.

Calibrating Using Auto Calibration

If **CL EXPRD** is set to **NOT USE** and calibration becomes due, then the unit must be calibrated using this menu item and/or the next menu item, **ONE CAL**, because it will not be possible to enter normal operation. See “Calibration/Bump Test Supplies and Equipment” on page 56 for the items you will need to perform a calibration. These instructions assume you are using a 4-gas cylinder and a % volume methane cylinder.

1. Perform a fresh air adjust. See previous section for instructions.
2. Install the demand flow regulator onto the calibration cylinder.

3. Connect the sample tubing to the demand flow regulator.
4. Install the hose and probe to the GX-2012.
5. You may only calibrate either the standard 4 sensors or the % volume combustible gas sensor at a time. Once you are finished, you are returned to the initial AUTO CAL screen and must begin the auto calibration process again.
6. Use the AIR▲ or (SHIFT)▼ buttons to display the **AUTO CAL** menu item. Press and release the POWER ENTER button to display the calibration values screen. If you want to exit back to the main menu without completing a calibration, press and release the DISPLAY (ADJ) button.
7. Use the AIR▲ or (SHIFT)▼ button to alternate between the 4-gas and the % volume combustible gas calibration values screen.

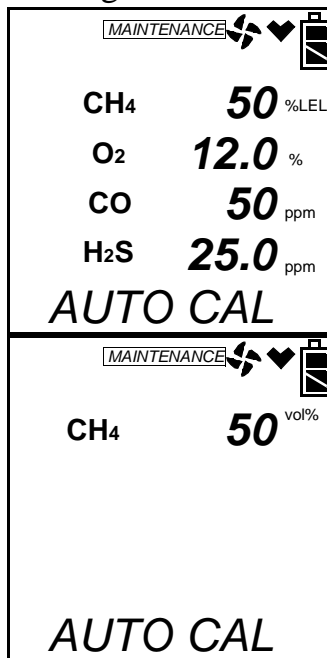

8. The gas concentrations displayed in the calibration values screens must match the gas concentrations listed on the calibration cylinders. If *all* concentrations match, go to step 16. If *one or more* concentrations do not match, continue with step 9.

9. To adjust the values on the screens, hold down the (SHIFT)▼ button, then press the DISPLAY(ADJ) button and release both. The %LEL sensor is shown.

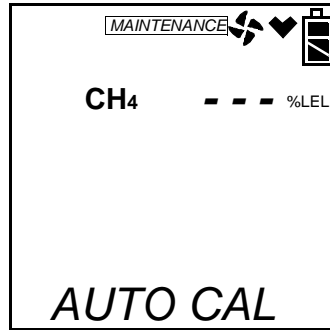

10. Use the AIR▲ and (SHIFT)▼ buttons to scroll through the sensors and select the sensor whose calibration gas value you want to adjust.
11. Press and release the POWER ENTER button. The sensor's calibration gas value will flash.
12. If necessary, use the AIR▲ and (SHIFT)▼ buttons to set the correct calibration gas value.
13. Press and release the POWER ENTER button to save the change.
14. Repeat steps 10 through 13 to set the correct values for any additional sensors.
15. After the last calibration gas value is set, use the AIR▲ button to scroll to ESCAPE and press POWER ENTER to return to the calibration gas values screen.

NOTE: The RKI Four Gas Cylinder typically contains 12% O₂ by volume. Be sure to set the "OXY" reading to agree with the concentration listed on the cylinder's label, not zero.

16. Use the AIR▲ and (SHIFT)▼ buttons to select which sensor(s) you want to calibrate, the standard 4 sensors or the % volume combustible gas sensor.

The following instructions illustrate calibrating the standard 4 sensor first, then the % volume combustible gas sensor.

17. With the calibration values screen displayed, press the POWER ENTER button. AUTO CAL begins to flash and the current gas readings are displayed.

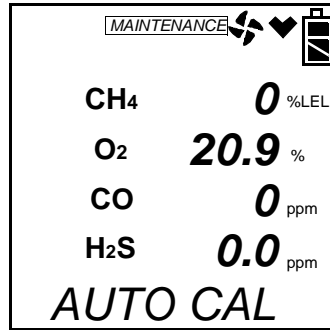

18. Connect the tubing from the demand flow regulator to the rigid tube on the probe. Allow the gas to flow for one minute.
19. Press and release the POWER ENTER button to set the calibration to the programmed values.

If all channels passed calibration, PASS displays along the bottom of the screen, then the calibration menu displays.

If any of the sensors cannot calibrate to the proper value, FAIL displays along the bottom of the screen and the GX-2012 lists the sensor(s) that failed to calibrate. In the example below, the OXY and H₂S channels failed calibration. The other sensors calibrated normally.

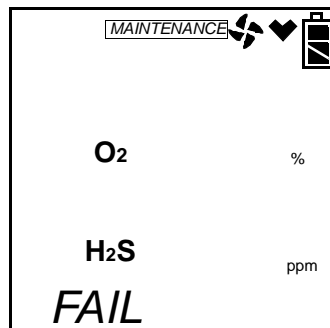

The buzzer and alarm lights activate. Press and release the RESET SILENCE button after the buzzer and lights stop to reset the alarm and return to the calibration menu. Attempt to calibrate again. If the failure continues, investigate the cause. See "Troubleshooting" on page 123.

20. Disconnect the tubing from the probe.
21. Unscrew the demand flow regulator from the calibration cylinder.
22. If you have a 5 sensor unit and wish to calibrate the % volume combustible gas sensor, go back to step 1 and repeat the process, selecting the % volume calibration gas value screen in step 16 and using a % volume methane calibration cylinder.

If you are finished calibrating, use the (SHIFT)▼ button to navigate to the **NORMAL** menu item, then press and release the **POWER ENTER** button to return to Measuring Mode.

Calibrating Using Single Calibration

If **CL EXPRD** is set to **NOT USE** and calibration becomes due, then the unit must be calibrated using this menu item and/or the previous menu item, **AUTO CAL** because it will not be possible to enter normal operation. See “Calibration/Bump Test Supplies and Equipment” on page 56 for the items you will need to perform a calibration.

1. Perform a fresh air adjust. See “Performing a Fresh Air Adjustment” on page 85 for instructions.
2. Install the demand flow regulator onto the calibration cylinder.
3. Connect the sample tubing to the demand flow regulator.
4. Install the hose and probe to the GX-2012.
5. Use the **AIR▲** or (SHIFT)▼ buttons to scroll to the **ONE CAL** menu option.



6. Press and release the **POWER ENTER** button to display the single calibration menu. The %LEL sensor will be displayed first.

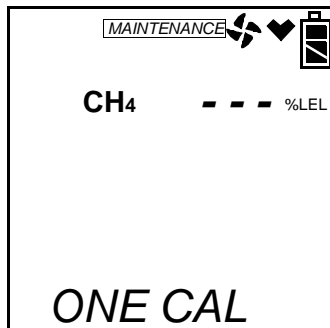

7. Use the AIR▲ or (SHIFT)▼ button to display the sensor you want to calibrate (in this example the combustible gas % LEL sensor). If you have a 5 sensor unit, the % vol sensor will be one of the choices. It is shown below.

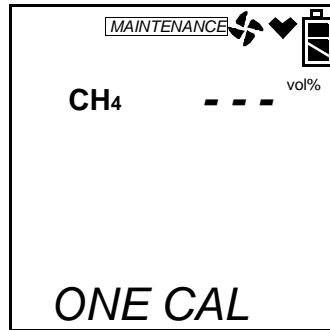

8. Press and release the POWER ENTER button. The single calibration screen displays for the sensor you selected. The gas reading flashes.

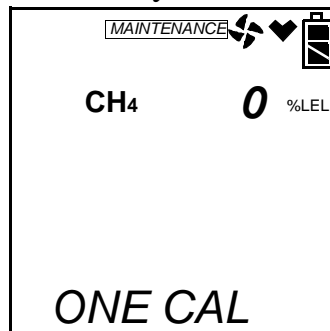

9. Connect the tubing from the demand flow regulator to the rigid tube on the probe. Allow the calibration gas to flow for one minute.
10. If necessary, use the AIR▲ and (SHIFT)▼ buttons to adjust the reading to match the concentration listed on the calibration cylinder.
11. Press and release the POWER ENTER button to save the span value. The LCD will indicate that the calibration has ended, then the single calibration menu displays.
12. Disconnect the tubing from the probe.
13. Repeat steps 2 through 12 for any other sensors you want to calibrate. Make sure you use an appropriate calibration cylinder for each sensor.

CAUTION: When calibrating the oxygen channel, verify the concentration of oxygen listed on the cylinder's label. For oxygen-free samples (100% nitrogen for example), set the oxygen zero setting to 0.0%.

14. After the last channel is calibrated, disconnect the calibration tubing from the probe, then unscrew the demand flow regulator from the calibration cylinder.

15. Use the AIR▲ and (SHIFT)▼ buttons to scroll to ESCAPE in the ONE CAL menu.
16. With the **ONE CAL** menu option displayed, press the (SHIFT)▼ button until the **NORMAL** menu option is displayed.
17. Press and release the POWER ENTER button to return to Measuring Mode.

Performing a Bump Test

NOTE: The **BUMP DSP** menu item in Maintenance Mode is factory set to OFF. The **BUMP** menu item will not appear unless **BUMP DSP** is set to ON. See “Turning the Bump Test Function On or Off” on page 106 for instructions.

NOTE: The GX-2012 uses parameters defined in the **BUMP--SET** menu item of Maintenance Mode while performing a bump test. To view or update these parameters, see “Updating the Bump Test Parameters” on page 108.

If the **BP RMNDR** menu item in Maintenance Mode is set to ON (see “Updating the Bump Test Reminder Setting” on page 114), and the **BP EXPRD** menu item in Maintenance Mode is set to NOT USE (see “Updating the Bump Test Expired Action Setting” on page 114) and a bump test becomes due, then the sensors must be bump tested using this menu item because it will not be possible to enter normal operation. See “Calibration/ Bump Test Supplies and Equipment” on page 56 for the items you will need to perform a bump test. These instructions assume you are using a 4-gas cylinder and a % volume cylinder.

1. Before performing a bump test, perform a fresh air adjustment as described in “Performing a Fresh Air Adjustment” on page 85.
2. Install the demand flow regulator onto the calibration cylinder.
3. Connect the sample tubing to the demand flow regulator.
4. Install the hose and probe to the GX-2012.

5. Use the AIR▲ or (SHIFT)▼ buttons to display the **BUMP** menu item.

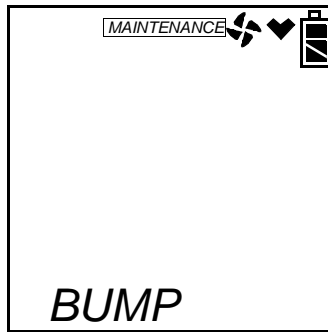

6. Press and release the POWER ENTER button to display the bump test gas values.

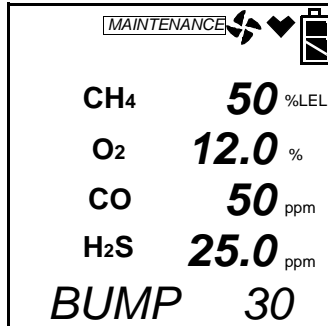

7. Use the AIR▲ or (SHIFT)▼ buttons to see the % volume combustible gas bump test value.

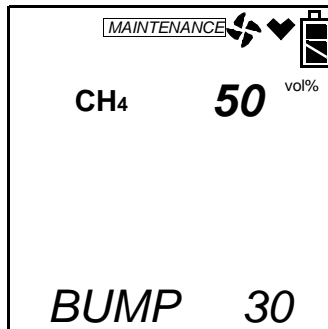

NOTE: If you wish to change any of the bump test gas values, you must exit the **BUMP** menu item and enter the **AUTO CAL** menu item. See steps 8 through 15 in “Calibrating Using Auto Calibration” on page 86 for instructions to change the gas values.

8. A bump test may be performed on the standard 4 sensors or on the % volume combustible sensor. Use the AIR▲ or (SHIFT)▼ buttons to display the screen for the sensor(s) you wish to bump test.
9. Before proceeding, confirm that the bump test gas value(s) are the same as the concentration(s) in the calibration cylinder. If they are not, adjust the bump test gas value(s) by entering the **AUTO CAL** menu item, changing the values there, and reentering the **BUMP** menu.

10. Connect the tubing from the demand flow regulator to the rigid tube on the probe and quickly press and release the POWER ENTER button. The unit will begin counting down from 30.
11. When AUTO CAL in the **BUMP--SET** menu item in Maintenance Mode is set to OFF:
 - The instrument will indicate which channels passed or failed the bump test with a P (pass) or an F (fail) to the right of the gas.

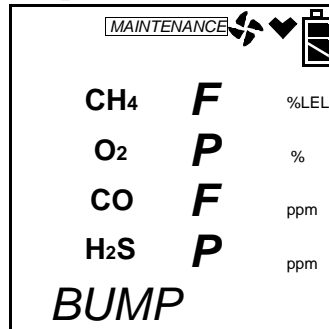

- To view the bump test gas readings press the AIR▲ or (SHIFT)▼ button. You can scroll between the bump test results and the bump test gas readings with the AIR▲ or (SHIFT)▼ button.

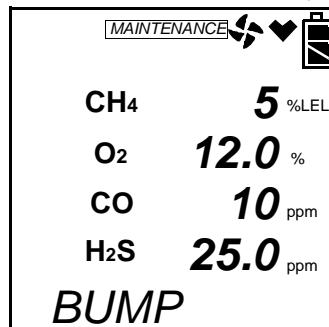

- To return to the main menu, press POWER ENTER.

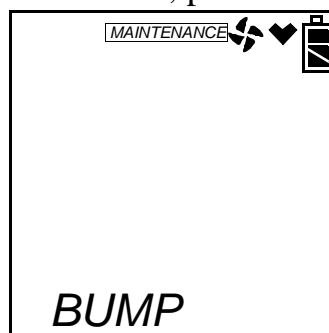

If one or more sensors fail the bump test, see “Troubleshooting” on page 123 to investigate the cause of the failure and replace the failed sensor or sensors if necessary.

- Disconnect the tubing from the probe.

12. When AUTO CAL in the **BUMP--SET** menu item in Maintenance Mode is set to ON:

If all channels pass the bump test,

- The following screen appears:

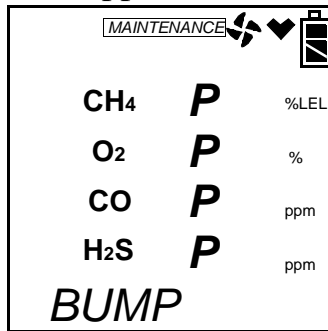

- To view the bump test gas readings press the AIR▲ or (SHIFT)▼ button. You can scroll between the bump test results and the bump test gas readings with the AIR▲ or (SHIFT)▼ button.

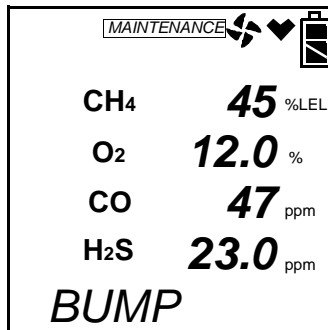

- To return to the main menu, press POWER ENTER.

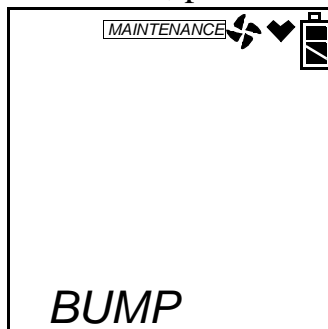

- Disconnect the tubing from the probe.

If any channel fails the bump test,

- The instrument will beep and a calibration is immediately and automatically started. Continue to apply the calibration gas. CAL on the bottom left of the screen will alternate with APPLY.

The calibration time will begin to countdown in seconds in the lower right of the screen. The calibration time counted down during a calibration initiated because of a failed bump test is the difference

between the bump test gas time and the calibration time defined in the **BUMP--SET** menu item in Maintenance Mode.

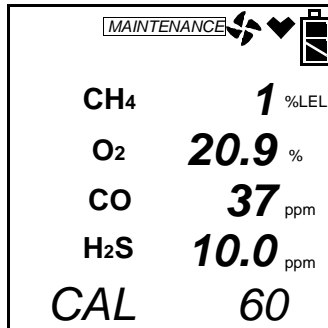

- At the end of the calibration, the instrument displays the results from both the bump test and the calibration. Use the AIR▲ or (SHIFT)▼ button to scroll between the calibration/bump test results, the bump test gas readings, and the calibration gas readings.

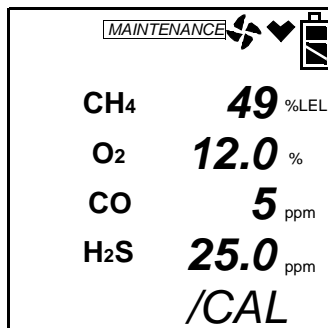
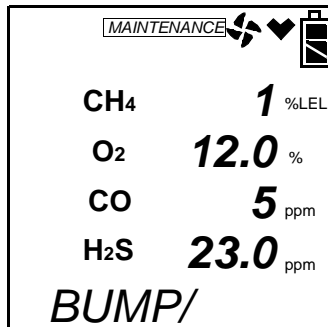
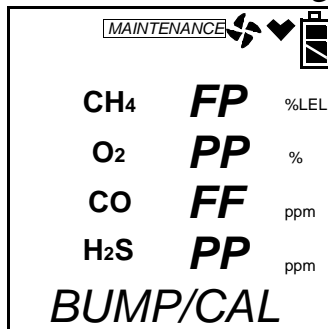

- To return to the main menu, press POWER ENTER at any time. If any channel failed the calibration, the buzzer will sound a double pulsing tone until you press and release the POWER ENTER button.

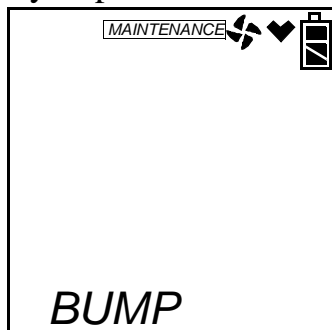

- Disconnect the tubing from the probe.
13. Unscrew the demand flow regulator from the calibration cylinder.
 14. With the **BUMP** menu option displayed, press the (SHIFT)▼ button until the **NORMAL** menu option is displayed.
 15. Press and release the POWER ENTER button to return to Measuring Mode.

Turning the Lunch Break Setting On or Off

With **LNCH BRK** set to **OFF** (factory setting), the GX-2012 automatically starts new TWA and PEAK reading collection and resets the time in operation at startup.

With **LNCH BRK** set to **ON**, the Resume Measurements Screen displays during startup. From this screen, you can choose to continue accumulating TWA and PEAK readings and the time in operation from the last time the GX-2012 was used or start collecting new readings and reset the time in operation.

1. Use the AIR▲ or (SHIFT)▼ buttons to display the **LNCH BRK** menu item.

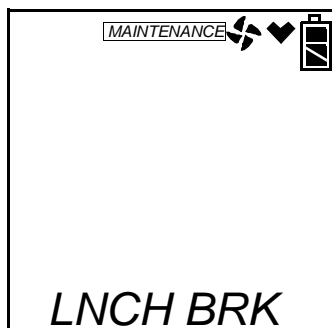

2. Press and release the POWER ENTER button. The screen will indicate the current setting.

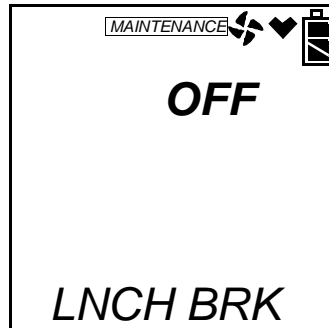

3. Use the AIR▲ or (SHIFT)▼ button to display the desired setting.
4. Press and release the POWER ENTER button to save the setting and return to the main menu.

Updating the Alarm Latching Setting

With **LATCHING** set to **ON** (factory setting), the GX-2012 remains in alarm condition until the alarm condition passes *and* the POWER ENTER button is pressed.

With **LATCHING** set to **OFF**, the GX-2012 automatically resets an alarm when the alarm condition passes.

1. Use the AIR▲ or (SHIFT)▼ buttons to display the **LATCHING** menu item.

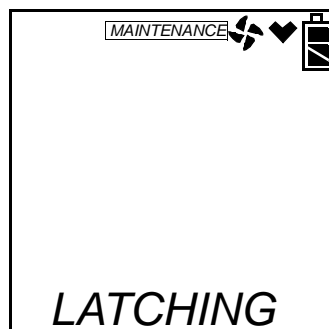

2. Press and release the POWER ENTER button. The screen will indicate the current setting.



3. Use the AIR▲ or (SHIFT)▼ button to display the desired setting.

4. Press and release the POWER ENTER button to save the setting and return to the main menu.

Updating the Alarm Silence Setting

With **ALM SLNC** set to **ON** (factory setting), pressing and releasing the **RESET SILENCE** button silences the buzzer when the GX-2012 is in alarm. The LEDs continue to flash and the display continues to show the alarm. If the alarms are set up as latching, when the gas concentration falls below the alarm level, pressing and releasing the **RESET SILENCE** button clears all alarm indications for that alarm. If an alarm condition occurs, you may still enter Display Mode by pressing the **DISPLAY (ADJ)** button. The buzzer will be silenced but the LEDs will continue to flash and the unit will continue to vibrate. If you return to Measuring Mode and there is still an alarm condition, the LEDs will continue to flash, the unit will continue to vibrate, and the buzzer will remain off. Once the condition clears, press the **RESET SILENCE** button to clear the alarm indications.

With **ALM SLNC** set to **OFF**, you cannot silence the buzzer. If an alarm condition occurs, and you enter Display Mode, the buzzer will not be silenced and the LEDs will continue to flash. Upon return to Measuring Mode, if there is still an alarm condition and the alarms are set up as latching, you must wait until it clears before you can press the **RESET SILENCE** button to clear the alarm indications.

1. Use the **AIR▲** or **(SHIFT)▼** buttons to display the **ALM SLNC** menu item.

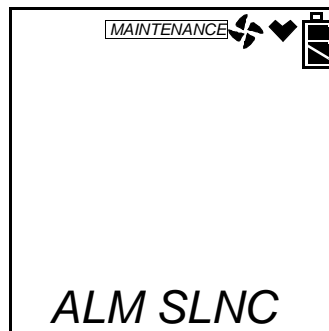

2. Press and release the POWER ENTER button. The screen will indicate the current setting.



3. Use the AIR▲ or (SHIFT)▼ button to display the desired setting.
4. Press and release the POWER ENTER button to save the setting and return to the main menu.

Updating the Data Log Interval Setting

This setting indicates how often the GX-2012 saves readings to the data logger. The following interval times can be selected: 6 minutes, 5 minutes, 3 minutes, 1 minute, 30 seconds, 20 seconds, or 10 seconds. The factory setting is 5 minutes (300 seconds).

1. Use the AIR▲ or (SHIFT)▼ buttons to display the **LG INTVL** menu item.

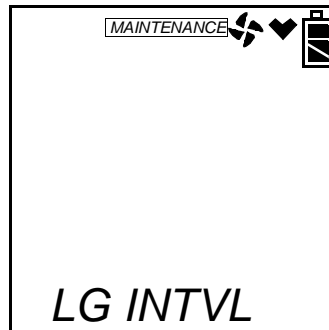

2. Press and release the POWER ENTER button. The screen will indicate the current setting.

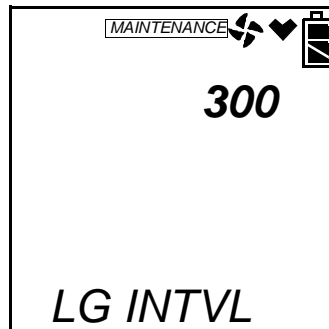

3. Use the AIR▲ or (SHIFT)▼ button to display the desired setting.
4. Press and release the POWER ENTER button to save the setting and return to the main menu.

Updating the Alarm Point Settings

The **ALARM--P** menu item allows you to update one or more warning, alarm, STEL, and TWA (for CO and H₂S) settings (the reading at which the GX-2012 recognizes these conditions).

Table 7: Factory Set Alarm Points

Channel	Warning	Alarm	STEL	TWA
Combustible Gas	10% LEL	50% LEL	N/A	N/A
Oxygen	19.5% decreasing	23.5% increasing	N/A	N/A
CO	25 ppm	50 ppm	200 ppm	25 ppm
H ₂ S	5 ppm	30 ppm	15 ppm	10 ppm

For the combustible gas channel, it is not possible to adjust either the Warning or Alarm settings to be higher than 60 %LEL. In addition, the Warning setting cannot be adjusted higher than the Alarm setting for all channels.

NOTE: It is not necessary to adjust every setting for every channel when you enter this menu item. All settings are shown here for example.

1. Use the AIR▲ or (SHIFT)▼ buttons to display the **ALARM--P** menu item. Press and release the POWER ENTER button.

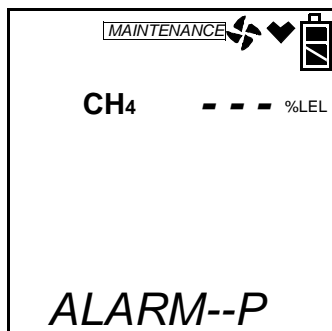

2. You may then select a channel. Use the AIR▲ or (SHIFT)▼ buttons to select a channel. The combustible gas channel is shown for example.

3. Press the POWER ENTER button to display the warning setting for the combustible channel. It will be flashing.

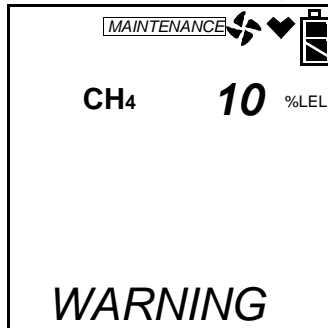

4. Use the AIR▲ or (SHIFT)▼ buttons to change the warning setting.
5. Press POWER ENTER to save the setting. The alarm setting for the combustible gas channel will then be displayed.

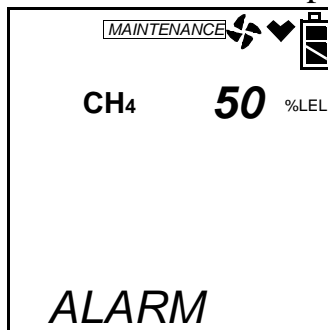

6. Use the AIR▲ or (SHIFT)▼ buttons to change the alarm setting.
7. Press POWER ENTER to save the setting. The unit will direct you back to the Alarm Points Screen where you can use the AIR▲ or (SHIFT)▼ buttons to select the oxygen channel.

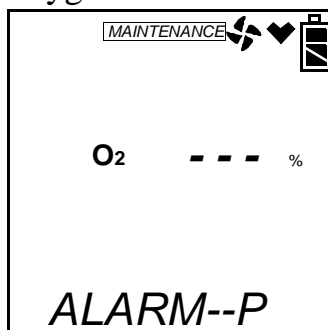

Press POWER ENTER.

8. The first selection for the oxygen channel is the alarm pattern.

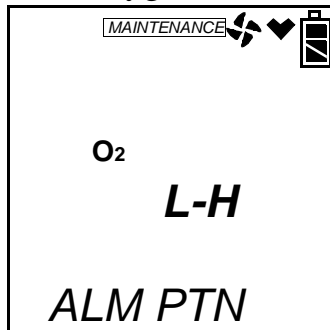

The choices are L-H, L-LL, or H-HH. The L-H pattern provides a decreasing warning and an increasing alarm. The L-LL pattern provides a decreasing warning and a decreasing alarm. The H-HH pattern provides an increasing warning and an increasing alarm. This setting is for operation in inert atmospheres and will cause INERT to appear along the bottom line of the display during Normal Operation. Make your selection using the AIR▲ or (SHIFT)▼ buttons and press POWER ENTER when finished. The factory setting is L-H.

9. You may then adjust the warning setting and alarm setting for the oxygen channel using the AIR▲ or (SHIFT)▼ buttons. Press POWER ENTER when finished with each selection to return to the Alarm Points Screen.
10. Use the AIR▲ or (SHIFT)▼ buttons to select the CO channel and press POWER ENTER to display the warning setting.
11. Adjust the values for the warning and alarm settings using the procedure in step 4 through step 7. When you press POWER ENTER after selecting the alarm value, you will then be prompted to select the STEL value.

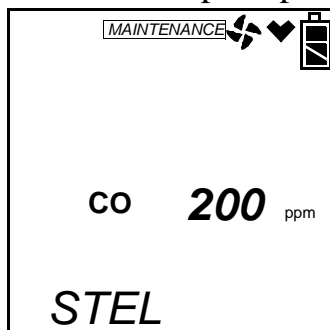

12. Use the AIR▲ or (SHIFT)▼ buttons to change the setting and press POWER ENTER when finished to save the setting. You will then be asked to enter a TWA value.

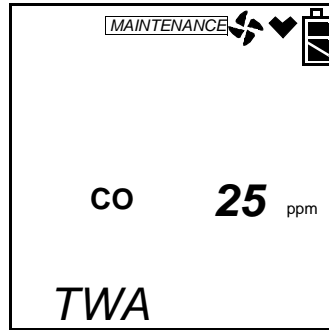

13. Use the AIR▲ or (SHIFT)▼ buttons to change the setting and press POWER ENTER when finished to save the setting and return to the Alarm Points Screen.

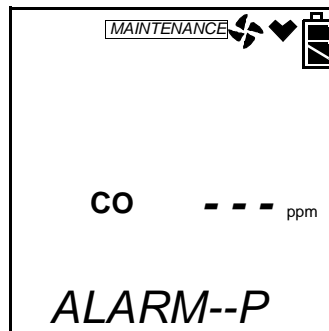

14. Use the AIR▲ or (SHIFT)▼ buttons to select the H₂S channel and press POWER ENTER. Adjust the values for the warning and alarm settings using the procedure in step 4 through step 7. When you press POWER ENTER after selecting the alarm value, you will then be prompted to select the STEL value as you were with the CO channel.

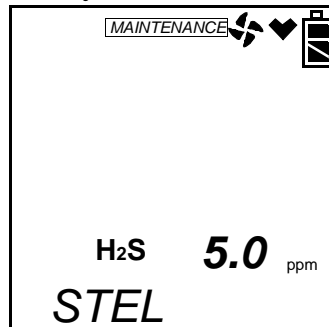

15. Use the AIR▲ or (SHIFT)▼ buttons to change the setting and press POWER ENTER when finished. You will then be asked to enter a TWA value.

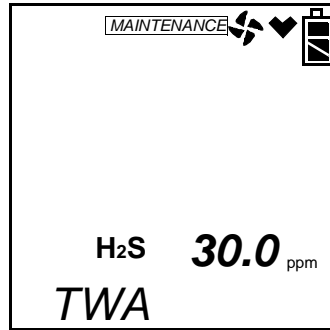

16. Use the AIR▲ or (SHIFT)▼ buttons to change the setting and press POWER ENTER when finished to return to the Alarm Points Screen.

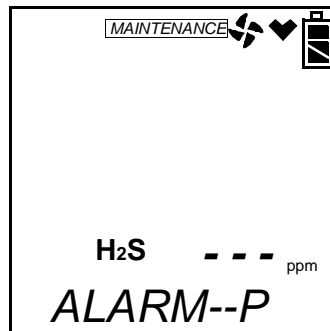

17. When you are finished making adjustments, use the AIR▲ or (SHIFT)▼ buttons to select ESCAPE and press POWER ENTER. You will be returned to the ALARM--P screen in the main menu.

Turning the Clear Data Logger Screen On or Off

The **DLOG DSP** menu item allows you to turn the Clear Data Logger Screen on or off. When set to ON (factory setting), the Clear Data Logger Screen appears in Display Mode and allows the user to clear any logged data. When set to OFF, the Clear Data Logger Screen does not appear in Display Mode and any logged data cannot be cleared from Display Mode.

1. Use the AIR▲ or (SHIFT)▼ buttons to display the **DLOG DSP** menu item.

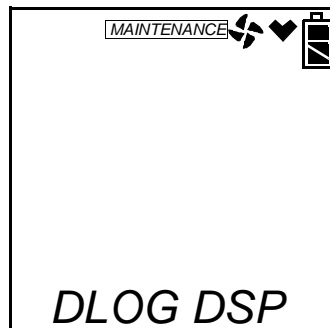

2. Press and release the POWER ENTER button. The screen will indicate the current setting.

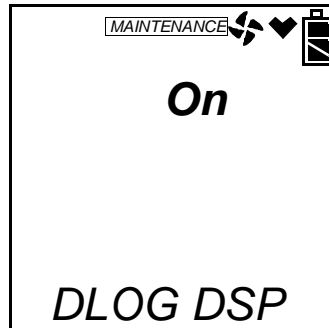

3. Use the AIR▲ or (SHIFT)▼ button to display the desired setting.
4. Press and release the POWER ENTER button to save the setting and return to the main menu.

Turning the Bump Test Function On or Off

The **BUMP DSP** menu item is used to turn the bump test function on or off. If set to OFF, the **BUMP** menu item in Calibration Mode and Maintenance Mode does not appear. In addition, the **BUMP--SET**, **BP INTVL**, **BP RMNDR**, and **BP EXPRD** menu items will not display in Maintenance Mode. The factory setting is **OFF**.

1. Use the AIR▲ or (SHIFT)▼ buttons to display the **BUMP DSP** menu item.

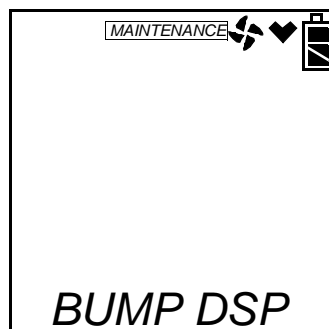

2. Press and release the POWER ENTER button. The screen will indicate the current setting.

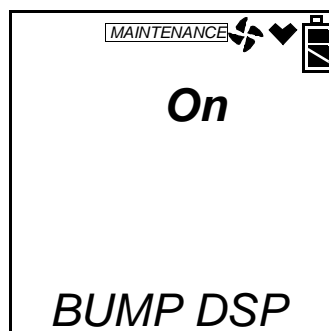

3. Use the AIR▲ or (SHIFT)▼ button to display the desired setting.

4. Press and release the POWER ENTER button to save the setting and return to the main menu.

Turning the Pump Off Screen On or Off

The **POFF DSP** menu item is used to turn the Pump Off Screen on or off. When set to ON, the Pump Off Screen appears in Display Mode and the user can turn off the pump in order to conserve battery power. If set to OFF (factory setting), the Pump Off Screen does not appear in Display Mode and the user cannot turn the pump off.

WARNING: *The GX-2012 is not a gas monitoring device if the pump is turned off.*

1. Use the AIR▲ or (SHIFT)▼ buttons to display the **POFF DSP** menu item.

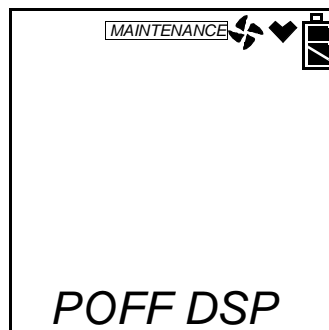

2. Press and release the POWER ENTER button. The screen will indicate the current setting.

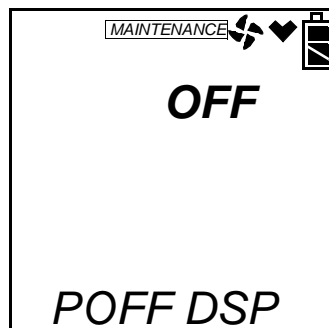

3. Use the AIR▲ or (SHIFT)▼ button to display the desired setting.
4. Press and release the POWER ENTER button to save the setting and return to the main menu.

Updating the Bump Test Parameters

The **BUMP--SET** menu item is used to adjust the bump test parameters.

NOTE: If the **BUMP DSP** menu item is set to OFF, this menu item does not appear.

1. Use the AIR▲ or (SHIFT)▼ buttons to display the **BUMP. SET** menu item.

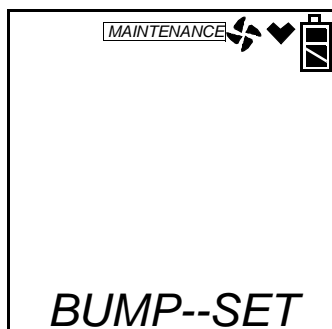

2. Press and release the POWER ENTER button. The values displayed are for GAS TIME, CHECK (bump test tolerance), CAL TIME, and AUTO CAL. The cursor on the left of the screen shows which setting is associated with the parameter shown at the bottom of the screen. Use the AIR▲ or (SHIFT)▼ buttons to scroll up or down along the list.

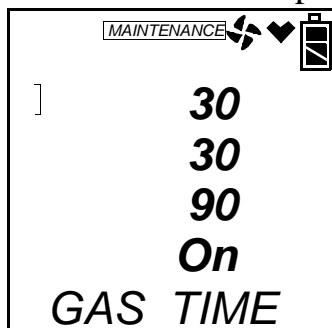

3. To update the GAS TIME setting, with the cursor next to the gas time and with GAS TIME displayed along the bottom of the screen, press POWER ENTER. The factory setting is 30 seconds. The value will begin to flash. Use the AIR▲ or (SHIFT)▼ buttons to select a new gas time. The GAS TIME is the amount of time that the instrument is exposed to gas during a bump test. The time increments are 30, 45, 60, and 90 seconds. Once a value is selected, press and release the POWER ENTER button to save it. The value will stop blinking.
4. To update the bump test tolerance, use the (SHIFT)▼ button to scroll to the CHECK value. The factory setting is 30%. This is the bump test tolerance value and is represented as a percentage. It is the percentage that the bump test reading can differ from the actual gas concentration. If the bump test reading differs more, the bump test will fail. With the

cursor next to the check value and CHECK displayed along the bottom of the screen, press and release POWER ENTER. The value will begin to flash. Use the AIR▲ or (SHIFT)▼ buttons to select a new threshold value. The available values are 10, 20, 30, 40, and 50. Once a value is selected, press and release the POWER ENTER button to save it. The value will stop blinking.

5. To update the CAL TIME setting, use the (SHIFT)▼ button to scroll to the CAL TIME value. The factory setting is 90 seconds. This is the length of time the instrument will remain exposed to calibration gas after a failed bump test if AUTO CAL is set to On. The bump test time is deducted from the calibration time. For example, if the CAL TIME is set to 90 seconds and the GAS TIME is set to 30 seconds, if the bump test fails, the GX-2012 will only be exposed to gas for an additional 60 seconds. With the cursor next to the cal time value and CAL TIME displayed along the bottom of the screen, press and release the POWER ENTER button. The value will begin to flash. Use the AIR▲ or (SHIFT)▼ buttons to select a new cal time value. The choices are 90 and 120 seconds. Once a value is selected, press and release the POWER ENTER button to save it. The value will stop blinking.
6. To update the AUTO CAL setting, use the (SHIFT)▼ button to scroll to the AUTO CAL value. The factory setting is ON. With AUTO CAL set to ON, if a bump test fails, the unit will automatically begin a calibration. If AUTO CAL is set to OFF and a bump test fails, nothing will happen. With the cursor next to the auto cal selection and AUTO CAL displayed along the bottom of the screen, press and release the POWER ENTER button. The value will begin to flash. Use the AIR▲ or (SHIFT)▼ buttons to select ON or OFF. Once a selection is made, press and release the POWER ENTER button to save it. The value will stop blinking.
7. To exit the **BUMP--SET** menu, use the (SHIFT)▼ button to scroll to ESCAPE and press and release the POWER ENTER button.

Updating the Confirmation Beep Setting

With **BEEP. SET** set to ON, the GX-2012 beeps once every 5 minutes to verify that it is operating.

With **BEEP. SET** set to OFF (factory setting), the GX-2012 does not sound a confirmation beep.

1. Use the AIR▲ or (SHIFT)▼ buttons to display the **BEEP. SET** menu item. Press and release the POWER ENTER button. The screen will indicate the current setting.

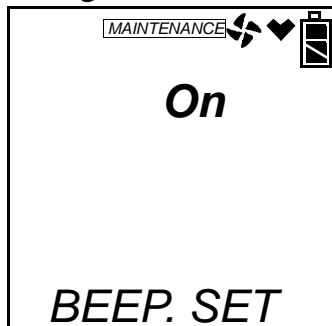

2. Use the AIR▲ or (SHIFT)▼ button to display the desired setting.
3. Press and release the POWER ENTER button to save the setting and return to the main menu.

Updating the Datalog Overwrite Setting

With **OVER WRT** set to ON (factory setting), the GX-2012 writes over the oldest data with new data when the data logger memory is full.

With **OVER WRT** set to OFF, the GX-2012 stops saving data to the data logger when the data logger memory is full.

1. Use the AIR▲ or (SHIFT)▼ buttons to display the **OVER WRT** menu item. Press and release the POWER ENTER button. The screen will indicate the current setting.

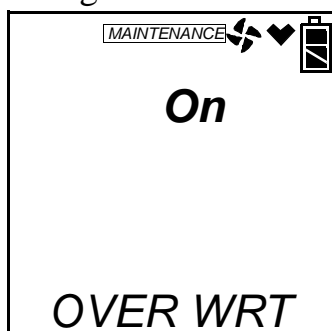

2. Use the AIR▲ or (SHIFT)▼ button to display the desired setting.
3. Press and release the POWER ENTER button to save the setting and return to the main menu.

Updating the Calibration Interval

This **CL INTVL** setting defines the amount of time between calibrations. The minimum setting is 1 day and the maximum setting is 255 days. The factory setting is 90 days.

1. Use the AIR▲ or (SHIFT)▼ buttons to display the **CL INTVL** menu item. Press and release the POWER ENTER button. The screen will indicate the current setting.

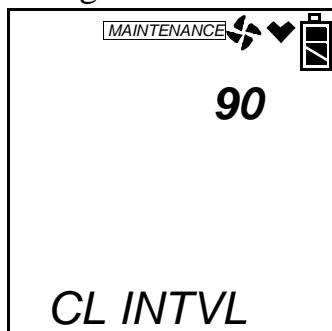

2. Use the AIR▲ or (SHIFT)▼ button to display the desired setting.

Tip: Press and hold the AIR▲ or (SHIFT)▼ button to rapidly scroll through the settings.

3. Press and release the POWER ENTER button to save the setting and return to the main menu.

Updating the Calibration Reminder Setting

With **CL RMNDR** set to **ON** (factory setting), the GX-2012 will give an indication at start up if it is due for calibration. The type of indication will depend on the **CL EXPRD** setting (see below).

1. Use the AIR▲ or (SHIFT)▼ buttons to display the **CL RMNDR** menu item. Press and release the POWER ENTER button. The screen will indicate the current setting.

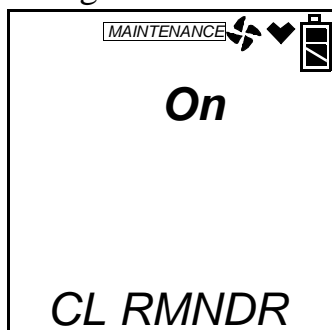

2. Use the AIR▲ or (SHIFT)▼ button to display the desired setting.
3. Press and release the POWER ENTER button to save the setting and return to the main menu.

Updating the Calibration Expired Action Setting

This item defines what indication is given during start up when calibration is due and **CL RMNDR** is set to **ON**.

With **CL EXPRD** set to **CONFIRM** (factory setting), the GX-2012 will give an indication at start up if calibration is due and require the user to press the **RESET SILENCE** button to continue.

With **CL EXPRD** set to **NOT USE**, if the unit is due for calibration the GX-2012 will give an indication at start up that calibration is due and the unit cannot be used until it is calibrated. With this setting, it is necessary to calibrate the instrument from Maintenance Mode if calibration is not performed before it is due. See “Calibrating Using Auto Calibration” on page 86 and “Calibrating Using Single Calibration” on page 90 for instructions.

With **CL EXPRD** set to **NO EFFECT**, no confirmation during startup or calibration is required to use the GX-2012.

1. Use the **AIR▲** or **(SHIFT)▼** buttons to display the **CL EXPRD** menu item. Press and release the **POWER ENTER** button. The screen will indicate the current setting.

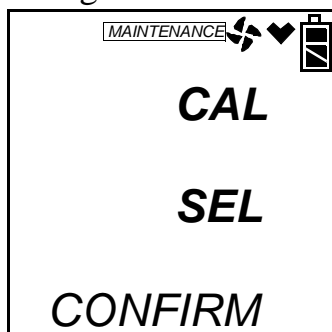

2. Use the **AIR▲** or **(SHIFT)▼** button to display the desired setting along the bottom of the screen.
3. Press and release the **POWER ENTER** button to save the setting and return to the main menu.

Updating the Calibration Check Setting

This item setting defines which sensors are used to update the calibration reminder screen. **C--CHECK** can be set to 4-GAS or ALL. If **C--CHECK** is set to 4-GAS (factory setting), the calibration dates for only the standard 4 sensors (LEL, O₂, H₂S, and CO) are used to determine if calibration is due. If **C--CHECK** is set to ALL, the calibration dates for the standard 4 sensors along with the %volume sensor are used to determine if a calibration is due.

1. Use the AIR▲ or (SHIFT)▼ buttons to display the **C--CHECK** menu item. Press and release the POWER ENTER button. The screen will indicate the current setting.

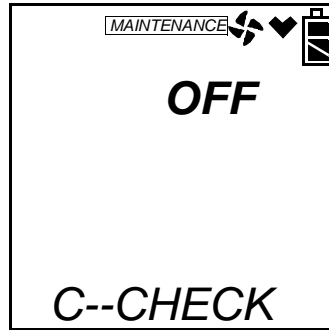

2. Use the AIR▲ or (SHIFT)▼ button to display the desired setting.
3. Press and release the POWER ENTER button to save the setting and return to the main menu.

Updating the Bump Test Interval

This **BP INTVL** setting defines the amount of time between bump tests. The minimum setting is 0 days and the maximum setting is 30 days. The factory setting is 30 days.

NOTE: If the **BUMP DSP** menu item is set to OFF, this menu item does not appear.

1. Use the AIR▲ or (SHIFT)▼ buttons to display the **BP INTVL** menu item. Press and release the POWER ENTER button. The screen indicates the current setting.

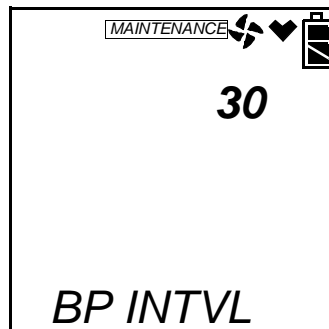

2. Use the AIR▲ or (SHIFT)▼ button to display the desired setting.

Tip: Press and hold the AIR▲ or (SHIFT)▼ button to rapidly scroll through the settings.

3. Press and release the POWER ENTER button to save the setting and return to the main menu.

Updating the Bump Test Reminder Setting

With **BP RMNDR** set to **ON**, the GX-2012 will give an indication at start up if it is due for bump testing. The type of indication will depend on the **BP EXPRD** setting (see below).

With **BP RMNDR** set to **OFF** (factory setting), the GX-2012 will give no indication at start up if it is due for bump testing.

NOTE: If the **BUMP DSP** menu item is set to OFF, this menu item does not appear.

1. Use the AIR▲ or (SHIFT)▼ buttons to display the **BP RMNDR** menu item. Press and release the POWER ENTER button. The screen will indicate the current setting.



2. Use the AIR▲ or (SHIFT)▼ button to display the desired setting.
3. Press and release the POWER ENTER button to save the setting and return to the main menu.

Updating the Bump Test Expired Action Setting

This item defines what indication is given during start up when a bump test is due and **BP RMNDR** is set to **ON**.

With **BP EXPRD** set to **CONFIRM** (factory setting), the GX-2012 will give an indication at start up if a bump test is due and require the user to press the **RESET SILENCE** button to continue.

With **BP EXPRD** set to **NOT USE**, if the unit is due for a bump test the GX-2012 will give an indication at start up that the bump test is due and the unit cannot be used until it is bump tested. With this setting, it is necessary to bump test the instrument from the Maintenance Mode if a bump test is not performed before it is due. See “Performing a Bump Test” on page 92 for instructions.

With **BP EXPRD** set to **NO EFFECT**, no confirmation during startup or bump test is required to use the GX-2012.

NOTE: If the **BUMP DSP** menu item is set to OFF, this menu item does not appear.

1. Use the AIR▲ or (SHIFT)▼ buttons to display the **BP EXPRD** menu item. Press and release the POWER ENTER button. The screen will indicate the current setting.

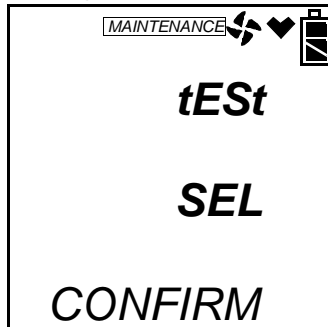

2. Use the AIR▲ or (SHIFT)▼ button to display the desired setting along the bottom of the screen.
3. Press and release the POWER ENTER button to save the setting and return to the main menu.

Updating the Bump Test Check Setting

This item setting defines which sensors are used to update the bump test reminder screen. **B--CHECK** can be set to 4-GAS or ALL. If **B--CHECK** is set to 4-GAS (factory setting), the calibration dates for only the standard 4 sensors (LEL, O₂, H₂S, and CO) are used to determine if a bump test is due. If **B--CHECK** is set to ALL, the calibration dates for the standard 4 sensors along with the % volume sensor are used to determine if a bump test is due.

1. Use the AIR▲ or (SHIFT)▼ buttons to display the **B--CHECK** menu item. Press and release the POWER ENTER button. The screen will indicate the current setting.

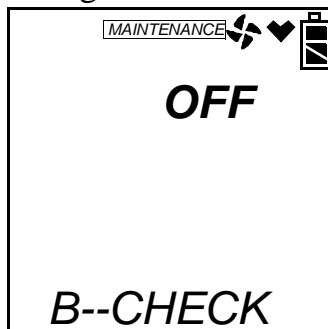

2. Use the AIR▲ or (SHIFT)▼ button to display the desired setting.
3. Press and release the POWER ENTER button to save the setting and return to the main menu.

Turning the ID Display Function On or Off

With **ID DISP** set to **ON**, the User ID Screen and Station ID Screens display during start up and in Display Mode. The ID's can be updated in Display Mode.

With **ID DISP** set to **OFF** (factory setting), the User ID Screen and Station ID Screens do not display during start up or in Display Mode.

1. Use the AIR▲ or (SHIFT)▼ buttons to display the **ID DISP** menu item. Press and release the POWER ENTER button. The screen will indicate the current setting.

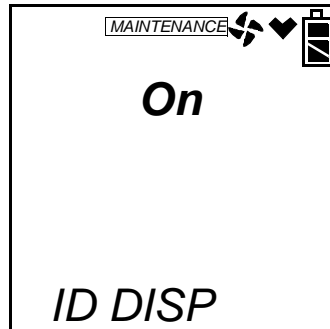

2. Use the AIR▲ or (SHIFT)▼ button to display the desired setting.
3. Press and release the POWER ENTER button to save the setting and return to the main menu.

Updating the LCD Back Light Time Setting

The **BCK LGHT** setting indicates the length of time the LCD illuminates when you press any button. The minimum setting is 0 seconds; the maximum setting is 255 seconds. The factory setting is 30 seconds.

NOTE: The backlight stays on during the entire warmup sequence.

1. Use the AIR▲ or (SHIFT)▼ buttons to display the **BCK LGHT** menu item. Press and release the POWER ENTER button. The screen will indicate the current setting.

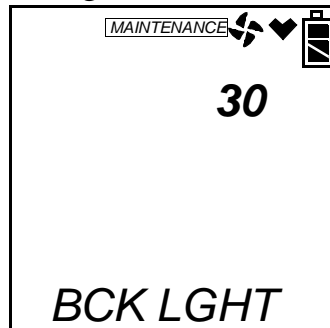

2. Use the AIR▲ and (SHIFT)▼ buttons to display the desired setting.
3. Press and release the POWER ENTER button to save the setting and

return to the main menu.

Updating the Autozero Function

With **AUTO.ZERO** turned **ON**, the GX-2012 will automatically perform a fresh air adjust when it is turned on. With the **AUTO.ZERO** function turned **OFF** (factory setting), this does not occur.

WARNING: *If you turn on the autozero function, you must ensure that the unit is in a fresh air environment when it is turned on.*

1. Use the AIR▲ or (SHIFT)▼ buttons to display the **AUTO.ZERO** menu item. Press and release the POWER ENTER button. The screen will indicate the current setting.

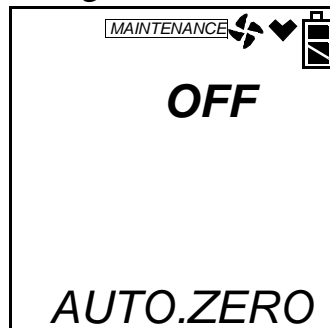

2. Use the AIR▲ or (SHIFT)▼ button to display the desired setting.
3. Press and release the POWER ENTER button to save the setting and return to the main menu.

Updating the Demand Zero Function

The **DEMAND Z** function allows you to manually perform a fresh air adjust in normal operation by pressing the AIR▲ button. The factory setting is **ON**.

1. Use the AIR▲ or (SHIFT)▼ buttons to display the **DEMAND Z** menu item. Press and release the POWER ENTER button. The screen will indicate the current setting.

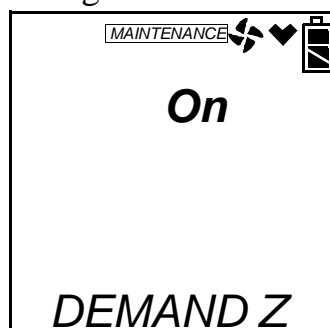

2. Use the AIR▲ or (SHIFT)▼ button to display the desired setting.
3. Press and release the POWER ENTER button to save the setting and return to the main menu.

Updating the Leak Check/Bar Hole Mode Setting

With **L./B. MODE** turned **OFF** (factory setting), the GX-2012 will automatically enter Normal Mode when it is turned on. With **L./B. MODE** set to bH, you will be prompted to choose between Normal Mode and Bar Hole Mode when the GX-2012 is turned on.

NOTE: The GX-2012 only supports Bar Hole Mode. It does not support Leak Check Mode.

1. Use the AIR▲ or (SHIFT)▼ buttons to display the **L./B. MODE** menu item.

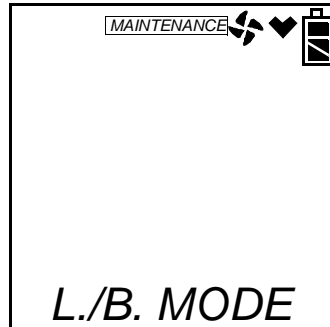

2. Press and release the POWER ENTER button. The screen will indicate the current setting.

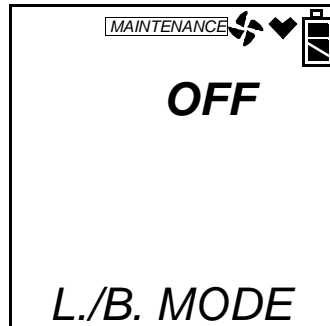

3. Use the AIR▲ or (SHIFT)▼ button to display the desired setting.
4. Press and release the POWER ENTER button to save the setting and return to the main menu.

Updating the Bar Hole Sampling Time

The Bar Hole Sampling Time is the amount of time that the GX-2012 samples a bar hole when being used in Bar Hole Mode. The 3 selections are 30, 45, and 60 seconds. The factory setting is 30 seconds.

1. Use the AIR▲ or (SHIFT)▼ buttons to display the **B.H. TIME** menu item.

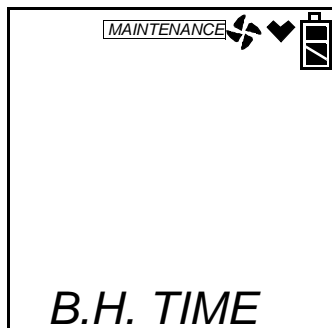

2. Press and release the POWER ENTER button. The screen will indicate the current setting.

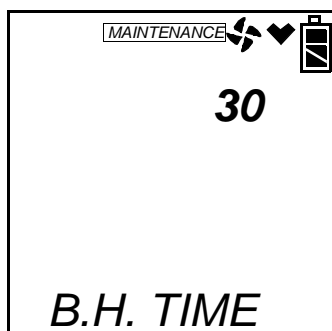

3. Use the AIR▲ or (SHIFT)▼ button to display the desired setting.
4. Press and release the POWER ENTER button to save the setting and return to the main menu.

ROM/SUM

The **ROM/SUM** screen shows the firmware version that is loaded in the instrument and the firmware checksum.

1. Use the AIR▲ button to scroll to the ROM/SUM screen. Press POWER ENTER and the ROM and SUM values for your unit will be displayed.

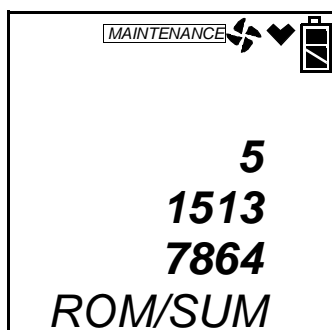

The first two lines display the ROM number. The ROM number indicates the firmware version number. In the above example, the ROM number is 51513. The bottom line displays the SUM number, 7864 in the above example.

2. Press **POWER ENTER** again to return to the ROM/SUM menu screen.

Turning the Password Function On or Off

With **PASSWORD** set to **ON**, the GX-2012 prompts you for a password when you enter Calibration Mode.

With **PASSWORD** set to **OFF** (factory setting), no password is required to enter Calibration Mode.

NOTE: A password is always required to enter Maintenance Mode even if **PASSWORD** is turned OFF. You may change the factory set password by turning **PASSWORD** ON and entering a new password when prompted for it.

1. Use the **AIR▲** or **(SHIFT)▼** buttons to display the **PASSWORD** menu item. Press and release the **POWER ENTER** button. The screen indicates the current setting.

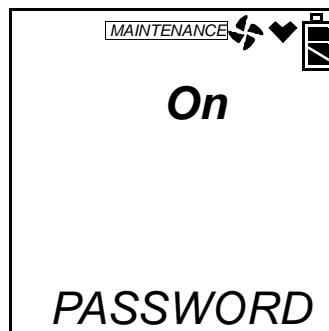

2. Use the **AIR▲** or **(SHIFT)▼** button to display the desired setting.
3. If you selected **OFF**, press and release the **POWER ENTER** button to save the setting and return to the main menu.

If you selected **ON**, press and release the **POWER ENTER** button. **ON** is replaced by the four characters making up the current password.

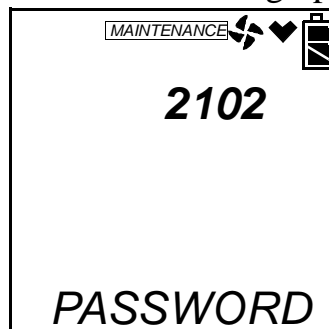

4. Use the AIR▲ or (SHIFT)▼ button to select a number from 0 to 9.
5. Press and release the POWER ENTER button to enter the selection and advance to the next character.
6. Repeat steps 4 and 5 to select the remaining characters. When you press and release the POWER ENTER button to enter the last number, the password is saved and you return to the main menu.

Performing a Low Flow Setpoint Adjustment

If your instrument repeatedly goes into low flow alarm and you have tried all of the recommendations in the Troubleshooting section, you may need to perform a low flow setpoint adjustment.

1. Use the AIR▲ or (SHIFT)▼ buttons to display the **FLOW ADJ** menu item. Press and release the POWER ENTER button. The pump will turn off and the screen will display values that reflect the pump's current draw.

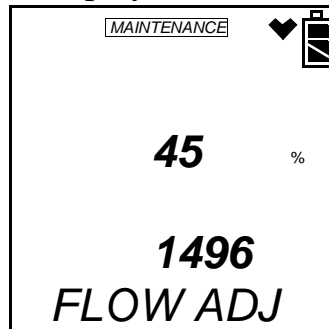

2. Use the AIR▲ or (SHIFT)▼ buttons to get a reading of approximately 1500 on the bottom value. When you have adjusted the value as close as you can, press and release the POWER ENTER button.
3. The pump will turn on and two new values will be displayed. The top will be a reference value and the bottom will reflect the pump's current draw.

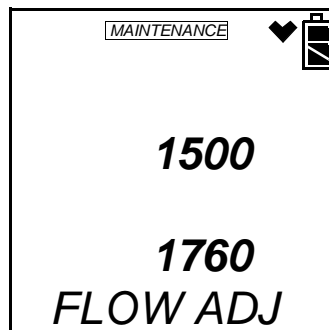

Connect a flow meter to the inlet of the instrument and adjust it to 0.5 SCFH \pm 0.1 SCFH. This will be the low flow setpoint. You do not need to adjust anything at the instrument. Once the low flow setpoint is set, press and release the POWER ENTER button.

4. You will return to the **FLOW ADJ** menu item in Maintenance Mode.

Exiting Maintenance Mode

1. Use the AIR▲ or (SHIFT)▼ buttons to display the **START** menu item. Press and release the POWER ENTER button.
2. The unit will exit Maintenance Mode and begin its start up sequence.

Chapter 6: GX-2012 Maintenance

Overview

This chapter describes troubleshooting procedures for the GX-2012. It also includes procedures for recharging the battery pack (rechargeable version), replacing the alkaline batteries (alkaline version), and replacing various consumable parts.

WARNING: *RKI Instruments, Inc. recommends that service, calibration, and repair of RKI instruments be performed by personnel properly trained for this work. Replacing sensors and other parts with original equipment does not affect the intrinsic safety of the instrument.*

Troubleshooting

The troubleshooting table describes error messages, symptoms, probable causes, and recommended action for problems you may encounter with the GX-2012.

Table 8: Troubleshooting the GX-2012

Symptoms	Probable Causes	Recommended Action
<ul style="list-style-type: none">The LCD is blank.	<ul style="list-style-type: none">The unit may have been turned off.The alkaline batteries may need to be replaced or the lithium ion battery pack recharged.	<ol style="list-style-type: none">To turn on the unit, press and briefly hold the POWER ENTER button.If the unit does not turn on, replace the alkaline batteries or recharge the lithium ion battery pack.If the difficulties continue, contact RKI Instruments, Inc. for further instruction.

Table 8: Troubleshooting the GX-2012

Symptoms	Probable Causes	Recommended Action
<ul style="list-style-type: none"> • Display indicates “FAIL SYSTEM” during startup along with an error code. 	<ul style="list-style-type: none"> • A circuit fault has occurred on one of the PCB's. 	<ol style="list-style-type: none"> 1. If the error code is 031, indicating a FLASH memory failure, press and release the RESET SILENCE button to continue to measuring mode keeping in mind that there will be no datalogging function. 2. If the error code is anything else, the instrument cannot be used. 3. Contact RKI Instruments, Inc. for further instruction if either 1 or 2 occur.
<ul style="list-style-type: none"> • Display indicates “FAIL CLOCK” during startup. 	<ul style="list-style-type: none"> • An internal clock failure has occurred because the date in the unit's memory is not a valid date. 	<ol style="list-style-type: none"> 1. Enter normal operation by pressing and releasing the RESET SILENCE button to use the unit temporarily. 2. Attempt to set the date in the DATE menu item in Maintenance Mode. 3. If you cannot set the date, contact RKI Instruments, Inc. for further instruction.
<ul style="list-style-type: none"> • Heart symbol at the top of the screen becomes steadily on or disappears 	<ul style="list-style-type: none"> • A microprocessor error has occurred. 	<ul style="list-style-type: none"> • Contact RKI Instruments, Inc. for further instruction.
<ul style="list-style-type: none"> • The LCD shows abnormally high or low readings but other gas detection instruments do not. 	<ul style="list-style-type: none"> • The LEL or CO filters may need to be replaced • The GX-2012 may need to be recalibrated. • The sensor for the affected channel(s) may need replacement. 	<ol style="list-style-type: none"> 1. If the abnormal reading is on the LEL channel, replace the LEL filter. If the abnormal reading is on the CO channel, replace the charcoal filter. 2. Recalibrate the unit. 3. If the difficulties continue, replace the sensor for the affected channel(s) and calibrate the affected channel(s). 4. If the difficulties continue, contact RKI Instruments for further instruction.

Table 8: Troubleshooting the GX-2012

Symptoms	Probable Causes	Recommended Action
<ul style="list-style-type: none"> • The unit indicates flow failure and does not recover when RESET SILENCE is pressed and released. 	<ul style="list-style-type: none"> • The cotton filter in the probe or filter holder is dirty and clogged. • The sample hose has a kink or obstruction. • The hydrophobic filter disks or wire mesh disk are dirty and clogged. • The pump is malfunctioning. 	<ol style="list-style-type: none"> 1. Change the cotton filter in the probe or filter holder. 2. Inspect the sample hose for kinks or obstructions and replace if necessary. 3. Inspect the hydrophobic filter disks and the wire mesh disk and replace if necessary. 4. Perform a low flow setpoint adjustment. For instructions, see “Performing a Low Flow Setpoint Adjustment” on page 121. 5. If difficulties continue, contact RKI Instruments for further instruction.
<ul style="list-style-type: none"> • Auto calibration fails or unable to set the response readings during single calibration. 	<ul style="list-style-type: none"> • The auto calibration values may not match the cylinder gas concentrations (auto calibration only). • The CO filter is saturated. • The sample gas is not reaching the sensor because of a bad connection. • The calibration cylinder may be out of gas or is outdated. • The sensor for the affected channel(s) may need replacement. 	<ol style="list-style-type: none"> 1. Check all calibration tubing for leaks or for any bad connections. 2. Make sure the GX-2012 has been properly set up for calibration. 3. Change the CO filter. 4. Verify that the calibration cylinder contains an adequate supply of fresh test sample. 5. If the fail condition continues, replace the sensor(s). 6. If the difficulties continue, contact RKI Instruments, Inc. for further instruction.

Replacing or Recharging the Batteries

WARNING: *To prevent ignition of a hazardous atmosphere, batteries must only be changed in an area known to be nonhazardous.*

Replace the batteries when the battery icon indicates that the unit is in low battery warning. When in low battery warning, the lowest battery level indication bar is displayed in the battery icon on the LCD, and it will be flashing.

Replacing Alkaline Batteries

NOTE: Use Procell PC 1500 alkaline batteries, Duracell MN 1500 alkaline batteries, or RKI Instruments lithium ion battery pack 49-1615RK to maintain the CSA classification of the GX-2012. Use of other batteries will void the CSA classification and may void the warranty.

1. Turn off the GX-2012.

WARNING: *Do not remove the batteries while the GX-2012 is on.*

2. Turn the battery cover release knob counterclockwise, remove the battery cover, and lay it aside.
3. Carefully remove the old alkaline batteries. Verify that the battery compartment and electrical contacts are clean.
4. Carefully install the new AA alkaline batteries according to the battery diagram inside the battery compartment.

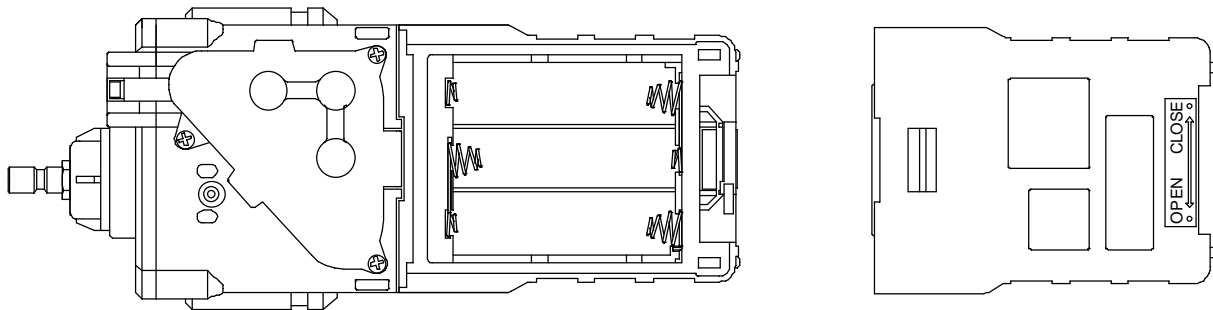

Figure 17: Installing the Alkaline Batteries

5. Reinstall the battery cover and turn the battery cover release knob clockwise to lock the cover in place.

Replacing the Lithium Ion Battery Pack

NOTE: Use Procell PC 1500 alkaline batteries, Duracell MN 1500 alkaline batteries, or RKI Instruments lithium ion battery pack 49-1615RK to maintain the CSA classification of the GX-2012. Use of other batteries will void the CSA classification and may void the warranty.

1. Turn off the GX-2012.

WARNING: *Do not remove the battery pack while the GX-2012 is on.*

2. Push the latch on the bottom of the GX-2012 toward the front of the instrument to release the battery pack.

Slide Latch This Way

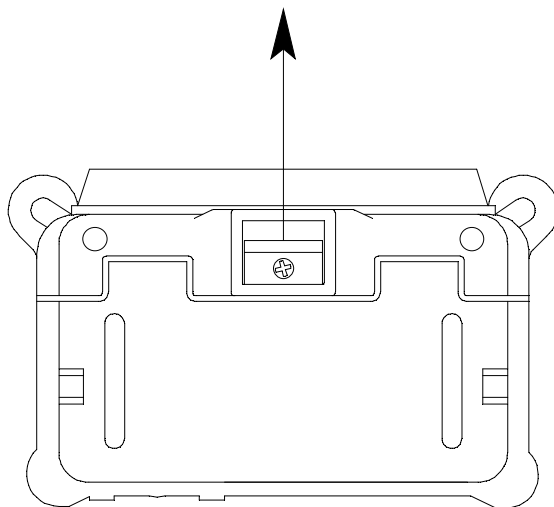

Figure 18: Releasing the Battery Pack

3. Slide the battery pack away from the instrument.
4. Insert a new battery pack ensuring that the slots and grooves on the sides are properly lined up. Push the battery pack into the instrument until you hear a click.

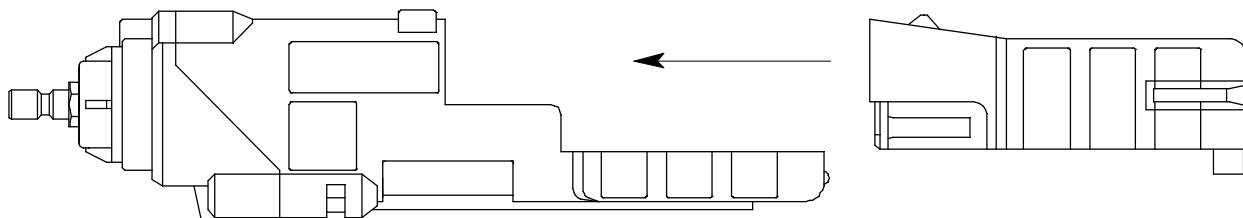
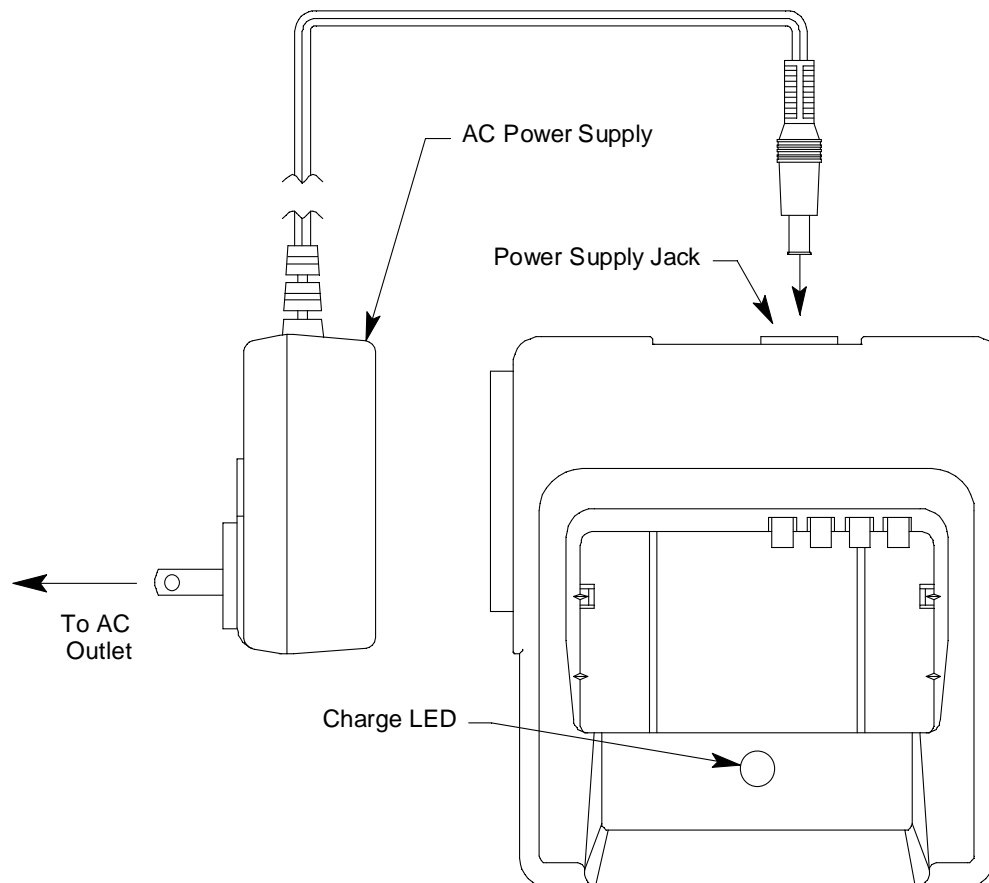

Figure 19: Installing the Battery Pack

Recharging the Lithium Ion Battery Pack in the Instrument

CAUTION: To be used only with lithium ion battery pack p/n 49-1615RK. Charge only with RKI charger model BC-2009, p/n 49-2180RK, or RKI charger model BC-2009DC, p/n 49-2181RK. Use of other rechargeable batteries or chargers or charging of other rechargeable batteries in the GX-2012 will void the warranty.

1. Make sure the GX-2012 is off.
2. Confirm that the adapter's DC output cord is plugged into the charger.
3. If using an AC powered charging station, plug the AC adapter into an electrical outlet.



AC Powered Charging Station

Figure 20: Connecting the Charging Station's AC Adapter

If using a DC powered charging station, plug the 12 VDC vehicle plug adapter into a vehicle's 12 VDC power socket.

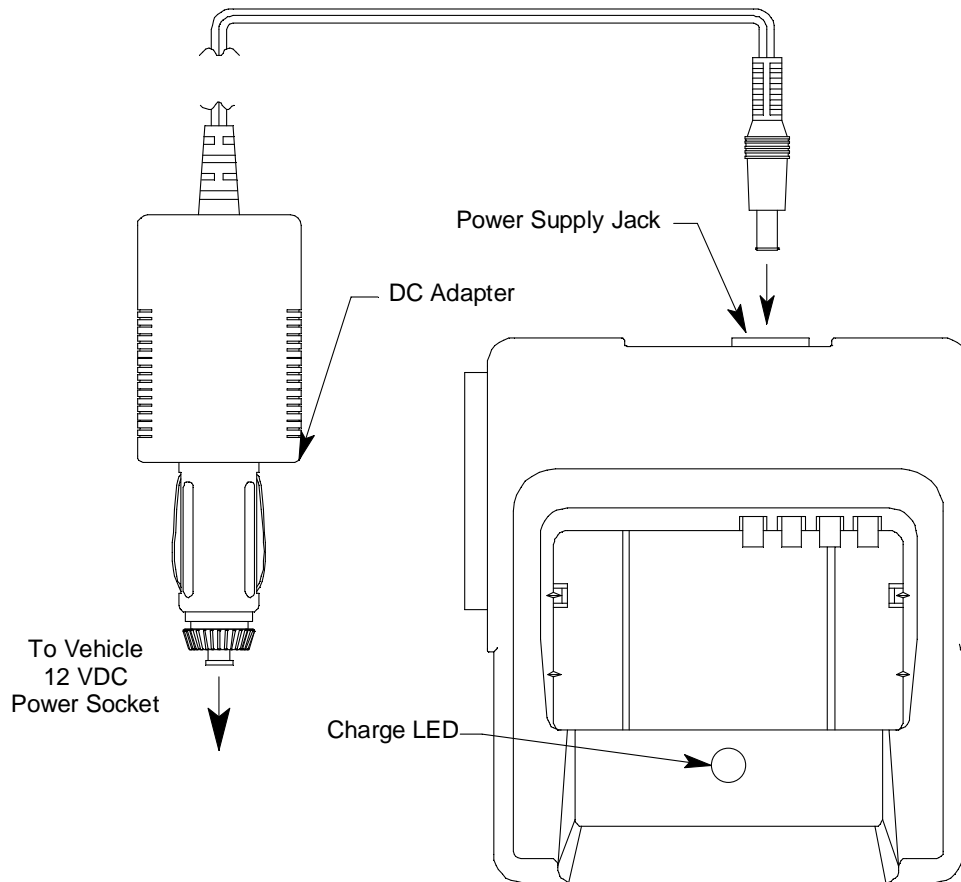

DC Powered Charging Station

Figure 21: Connecting the Charging Station's DC Adapter

The construction of the charging stations allows them to be chained together but a separate adapter must be used for each charging station. One adapter will not operate more than one charging station.

4. Place the GX-2012 into the battery charging station as shown in Figure 22 below so that the metal contacts on the back of the unit come into contact with the metal contacts on the back of the holder in the charging station. When proper contact has been made, the red LED on the charging station will turn on.

If you are using a DC adapter, the charging station comes with a velcro strap to secure the GX-2012. Ensure that both ends of the velcro strap are attached to the charging station and that it is securing the instrument.

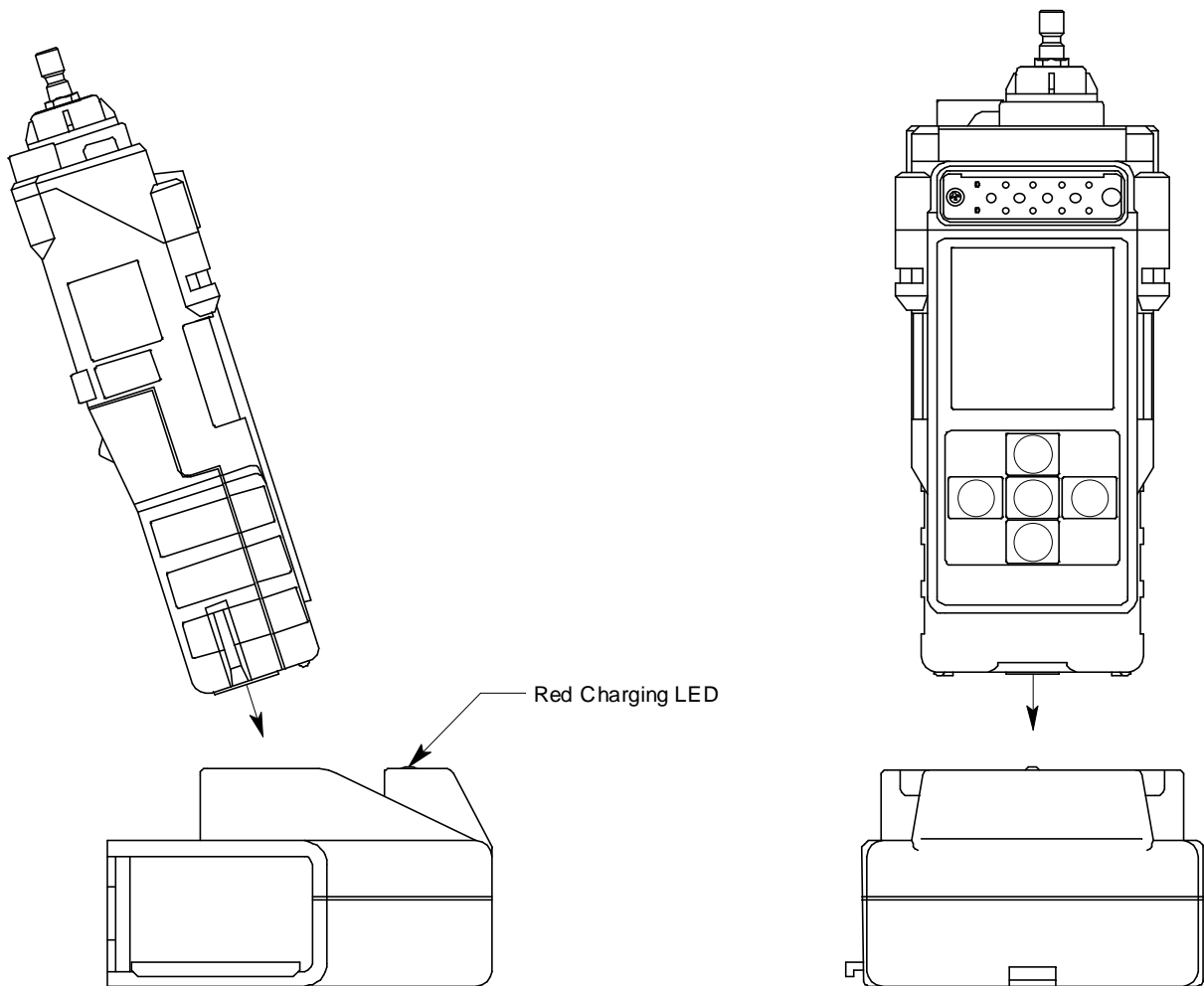

Figure 22: Putting the GX-2012 into the Charging Station

5. When a full charge has been reached, approximately 3 hours, the red LED on the charging station will turn off. Remove the GX-2012 from the charging station and unplug the charging station's power cord from the AC outlet.

Recharging the Lithium Ion Battery Pack Out of the Instrument

The lithium ion battery pack may be charged using the charging station while it is out of the GX-2012. This is useful if spare battery packs are kept in case the pack in the GX-2012 needs to be charged, but the unit must be used immediately. In this case, a spare charged pack can be installed in the GX-2012 and the dead pack charged in the charging station.

1. Make sure the GX-2012 is off.
2. Confirm that the adapter's DC output cord is plugged into the charger. If a multi-instrument charging station is being used, the same AC adapter is used as for the single instrument charging station.

3. If using an AC powered charging station, plug the AC adapter into an electrical outlet.

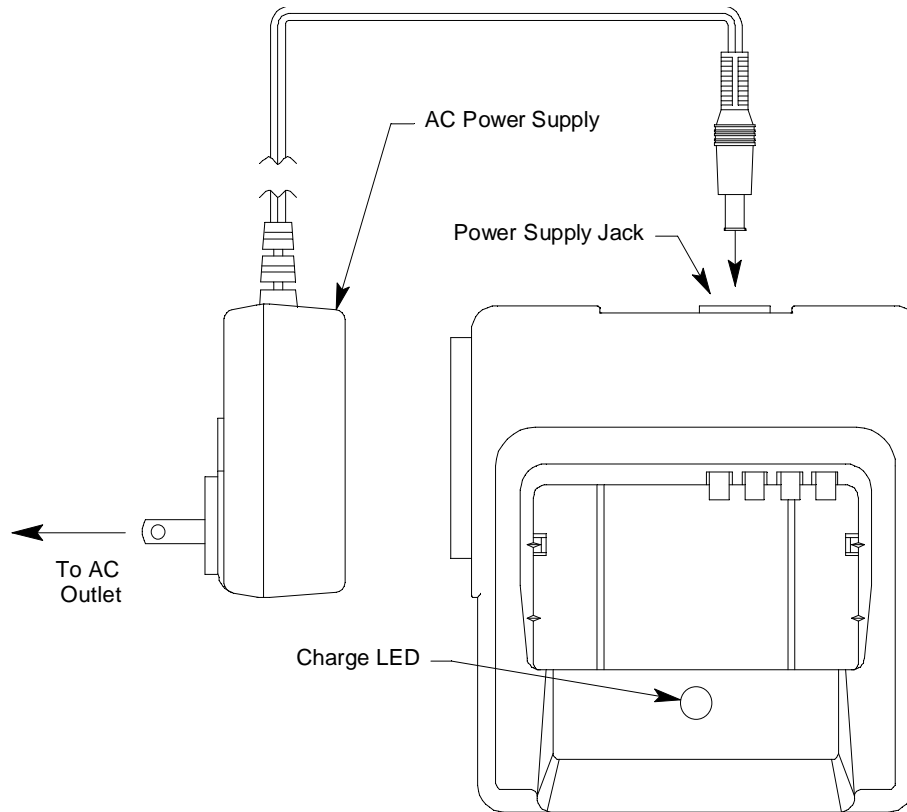

AC Powered Charging Station

Figure 23: Connecting the Charging Station's AC Adapter

If using a DC powered charging station, plug the 12 VDC vehicle plug adapter into a vehicle's 12 VDC power socket.

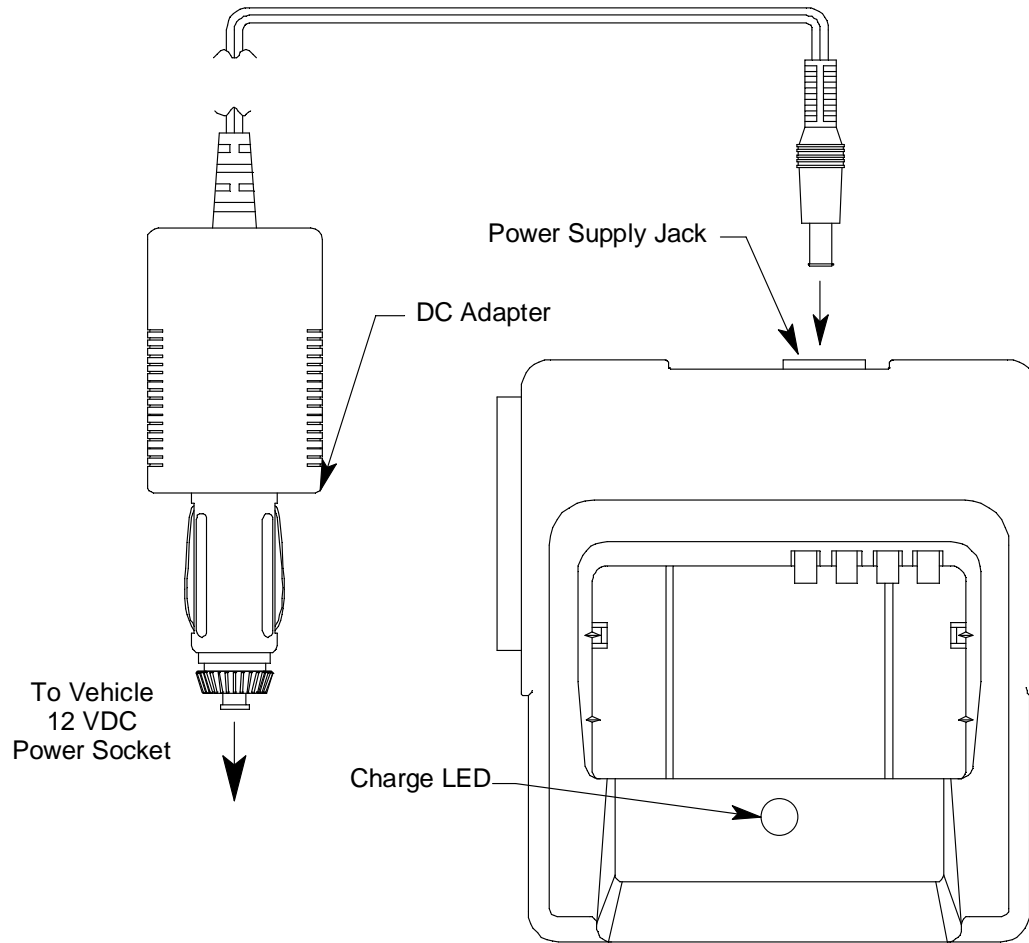

DC Powered Charging Station

Figure 24: Connecting the Charging Station's DC Adapter

The construction of the charging stations allows them to be chained together but a separate adapter must be used for each charging station. One adapter will not operate more than one charging station.

4. Insert the battery pack into the charging station as shown in Figure 25 below so that the metal contacts on the back of the battery pack come into contact with the metal contacts in the charging station. When proper contact has been made, the red LED on the charging station will turn on.

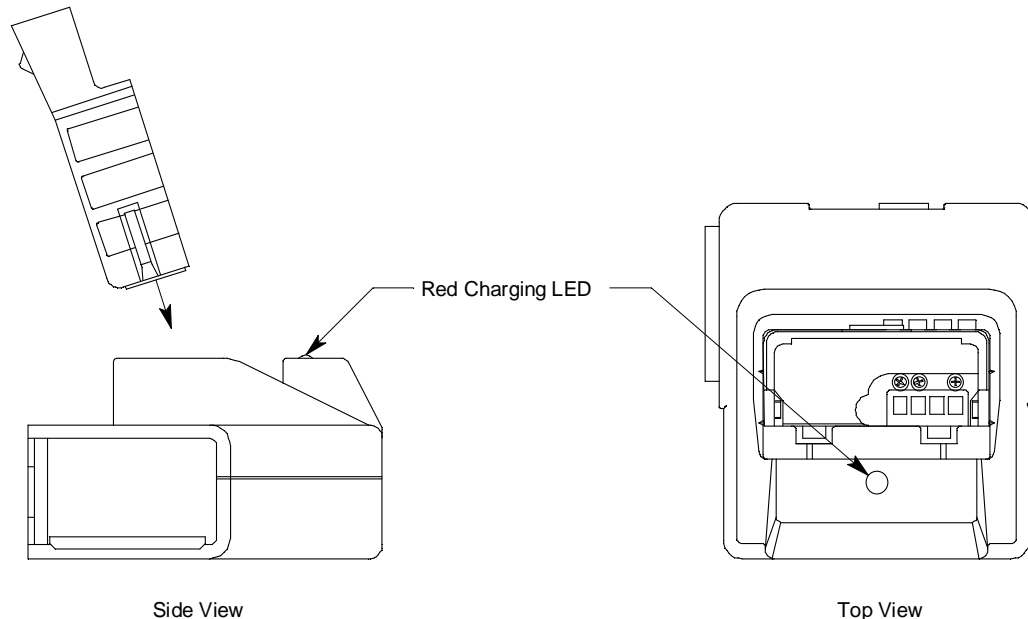

Figure 25: Putting the Battery Pack into the Charging Station

5. When a full charge has been reached, approximately 3 hours, the red LED on the charging station will turn off. Remove the battery pack from the charging station and unplug the charging station's power cord from the AC outlet.

Replacing the LEL and CO Filters

1. Verify that the GX-2012 is off.
2. Use a screwdriver to remove the three screws holding the belt clip to the back side of the instrument. Two of these screws also secure the flow chamber.
3. Remove the belt clip and unscrew the remaining screw holding in the flow chamber.
4. Grab the exhaust tube and pull it gently away from the unit to slide the flow chamber out of the unit. The CO (charcoal) filter may come out.
5. To replace the LEL filter, remove the old one from its recess in the sensor gasket and replace it with the new one making sure that it is properly seated. You do not have to remove the sensor gasket to replace the LEL filter. It sits in a recess on top of it.

- To replace the CO filter, pull the old one out of its recess in the sensor gasket if it did not already come out and replace it with a new one. You do not have to remove the sensor gasket to do this. The CO filter sits in a recess on top of it.

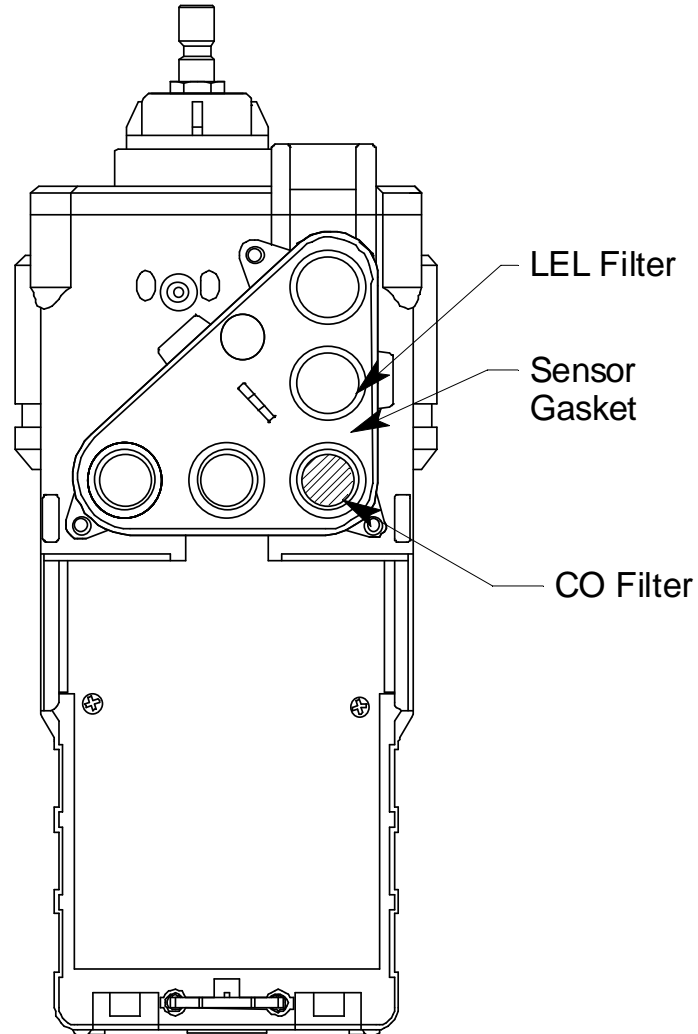

Figure 26: Replacing the LEL and CO Filters

- Insert the flow chamber back into the instrument.
- Tighten the top screw of the flow chamber completely.
- Place the belt clip into position and tighten the three screws retaining it.

Replacing a Sensor

1. Verify that the GX-2012 is off.
2. Use a screwdriver to remove the three screws holding the belt clip to the back side of the instrument. Two of these screws also secure the flow chamber.
3. Remove the belt clip and unscrew the remaining screw holding in the flow chamber.
4. Grab the exhaust tube and pull it gently away from the unit to slide the flow chamber out of the unit.
5. Gently pull on the knob of the sensor gasket to remove it. Be sure not to lose any of the filters that are in it. The sensors will be exposed.
6. Remove the sensor from its socket.
7. Carefully insert the replacement sensor in the correct socket.

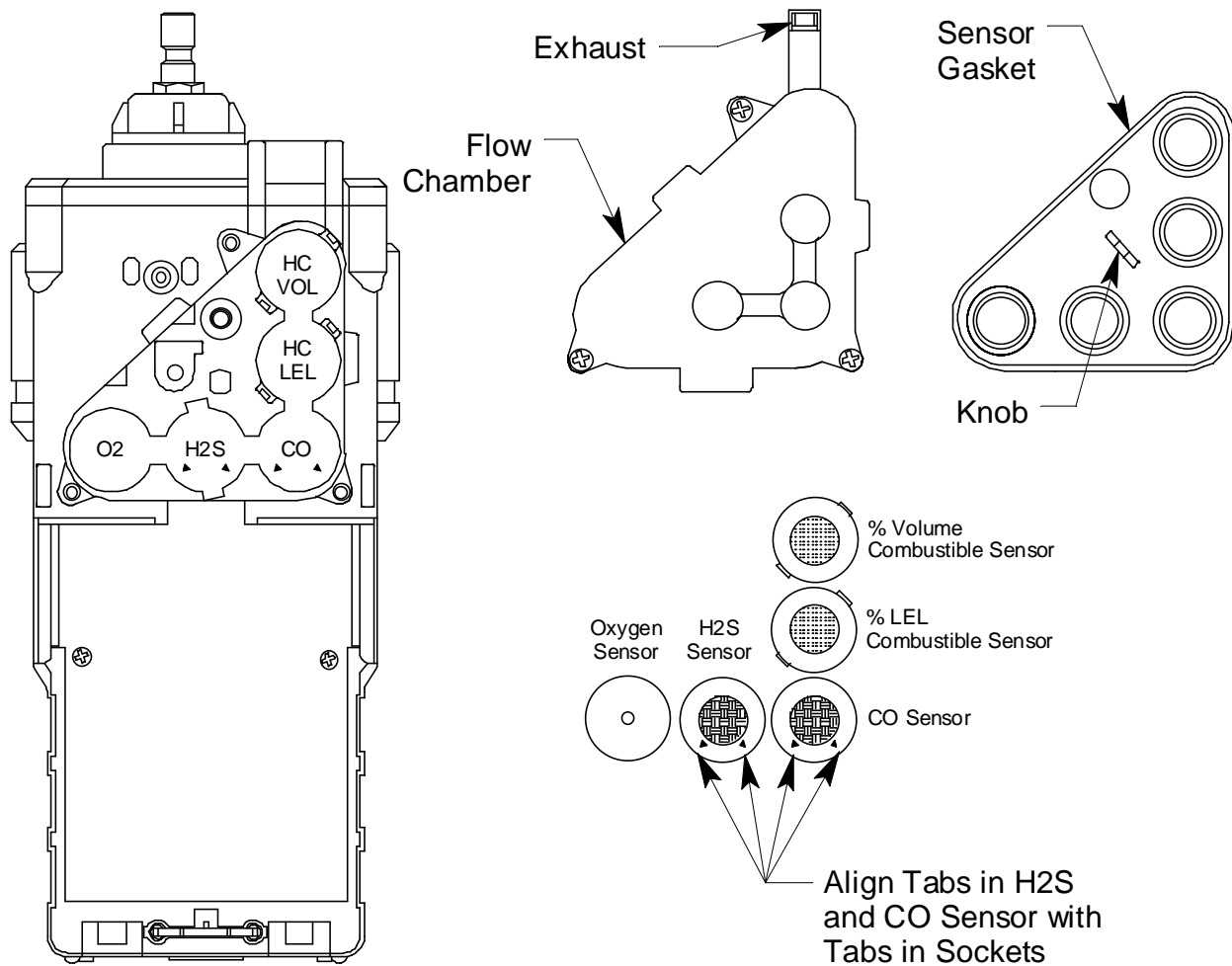

Figure 27: Replacing a Sensor

CAUTION: *When replacing a sensor, verify that the sensor is properly aligned with its socket before inserting it into the socket. The CO and H₂S sensors have alignment slots which match up with alignment tabs in the sockets. The combustible sensors each have two non-polarized contacts which must line up with the contacts in their socket. Forcing a sensor into its socket may damage the sensor or the socket.*

8. If your instrument has a factory installed dummy sensor, ensure that it is still installed correctly. Make sure that the flat side is up and the hollow side is down.
9. Place the sensor gasket and filters back into the chamber ensuring that it seals with the sensors and the edge of the chamber.
10. Place the flow chamber in position over the sensor area and press it into the case until it is flush with the back of the case.
11. Tighten the top screw of the flow chamber completely.
12. Place the belt clip into position and tighten the three screws retaining it.
13. Start up the GX-2012 by pressing and briefly holding the POWER ENTER button.
14. Calibrate the new sensor as described in “Calibration Mode” on page 56.

Replacing the Hydrophobic Disk Filter, Cotton Filter, and Wire Mesh Disk

1. Verify that the GX-2012 is off.
2. Locate the clear plastic filter holder at the top of the GX-2012.
3. Grasp the filter holder and turn it 1/4 turn counterclockwise.
4. Pull the filter holder away from the case. Inspect the cotton dust filter and replace if dirty.
5. The hydrophobic disk filters and wire mesh disk are located in the case and are retained by a rubber gasket. Pull out the rubber gasket with needle nose pliers.

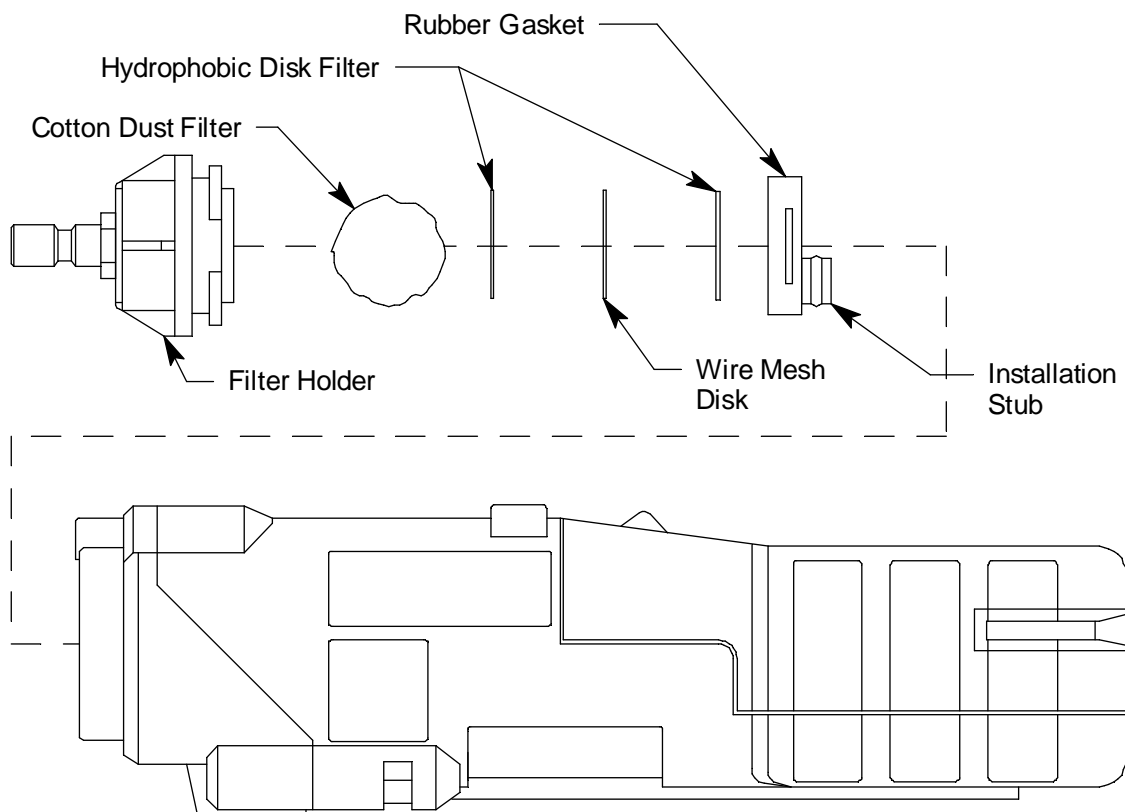

Figure 28: Changing the Filters & Wire Mesh Disk

6. Remove the old hydrophobic filters and/or wire mesh disk from the gasket. A hydrophobic filter is located on either side of the wire mesh disk.
7. Install the new hydrophobic filters and/or wire mesh disk making sure a hydrophobic filter is located on each side of the wire mesh disk.
8. Reinstall the gasket with the parts into the case. Ensure that the installation stub is lined up with the pump intake in the filter chamber.

9. Reinstall the filter holder with the cotton dust filter. Align the two wide tabs on the bottom of the filter holder with the two wide slots in the case where the filter holder fits. Push the filter holder into the case and turn it 1/4 turn clockwise until it snaps into place.

Parts List

Table 7 lists part numbers for the GX-2012's replacement parts and accessories.

Table 9: Parts List

Part Number	Description
06-1248RK-03	Calibration kit tubing, 3 foot length
07-2005RK	Gasket, filter/screen retaining
13-0112RK	Wrist strap
17-1001RK	Tapered rubber nozzle
17-4430RK-01	Purge tee fitting
21-1833RK	Filter holder, clear plastic
33-0159RK	Hydrophobic disk filter
33-1031RK	Cotton ball 25 pack, for replacement of cotton dust filter
33-1112RK	Wire mesh disk filter
33-7102RK	Charcoal filter disk, 5 pack, for CO sensor
33-7114RK	Filter disk, H ₂ S scrubber, 5 pack, for LEL sensor
47-5027RK	Downloading cable, USB/IrDA adapter
49-0115RK	AC adapter for charging station
49-1120RK	AA size alkaline battery
49-1615RK	Lithium ion battery pack
49-1616RK	Alkaline battery pack without batteries
49-1616RK-01	Battery cover, alkaline battery pack
49-1616RK-02	Battery base, without cover, alkaline battery pack
49-2020RK	DC adapter for charging station
49-2180RK	Charging station only, no AC adapter
49-2180RK-01	Charging station with AC adapter, 110/115/220 VAC
49-2181RK	Charging station with 12 VDC vehicle plug adapter

Table 9: Parts List (cont.)

Part Number	Description
71-0239RK	Operator's Manual, Model GX-2012 (this document)
71-0245RK	Operator's Manual, GX-2012 Data Logger Management Program
80-0009RK-XX	Sample hose. Replace "XX" with length in feet. Available lengths for the GX-2012 are 2, 3, 10, 15, 20, 25, 30, 40, and 50 feet.
80-0101RK	8 meter hose with floating head
80-0140RK	32" telescoping probe with dust filter
80-0144RK	7' telescoping probe with dust filter
80-0150RK	10" sample probe with dust filter
80-0155RK	30" aluminum probe
80-0157RK	30" fiberglass bar hole probe
80-0225RK	Hydrophobic filter
80-0404RK	1:1 dilution fitting
81-GX03CO	Calibration kit, for LEL/Oxy/CO unit, 58 liter
81-GX03CO-LV	Calibration kit, for LEL/Oxy/CO unit, 34 liter
81-GX03HSCO	Calibration kit, for LEL/Oxy/H2S/CO unit, 58 Liter
81-GX03HSCO-LV	Calibration kit, for LEL/Oxy/H2S/CO unit, 34 Liter
81-GX03VOLHS	Calibration kit, for %VOL(CH4)/LEL/Oxy/H2S/CO unit, 58 Liter
81-GX03VOLHS-LV	Calibration kit, for %VOL(CH4)/LEL/Oxy/H2S/CO unit, 34 Liter
81-0016RK-05	Calibration cylinder, 100% volume methane in nitrogen, 58 liter
81-0090RK-01	Calibration cylinder for demand-flow regulator kit, 34L; three-gas (CH ₄ ; O ₂ ; CO)
81-0090RK-03	Calibration cylinder for demand-flow regulator kit, 103L; three-gas (CH ₄ ; O ₂ ; CO)
81-0154RK-02	Calibration cylinder for demand-flow regulator kit, 58L; four-gas (CH ₄ ; O ₂ ; CO; H ₂ S)
81-0154RK-04	Calibration cylinder for demand-flow regulator kit, 34L; four-gas (CH ₄ ; O ₂ ; CO; H ₂ S)
81-1054RK	Regulator, demand-flow type (for 58- and 103-liter calibration cylinders)
83-0007RK	Downloading software
ES-1821	Carbon monoxide sensor
ES-1827i	Hydrogen sulfide sensor

Table 9: Parts List (cont.)

Part Number	Description
NC-6264A	% LEL combustibles sensor
OS-BM2	Oxygen sensor
TE-7561	TC %volume combustibles sensor

Appendix A: Calibrating and Bump Testing with a Sample Bag

Overview

The GX-2012 can be calibrated and bump tested with a gas bag calibration kit instead of a demand flow regulator kit. Appendix A describes how to use a sample bag calibration kit to calibrate and bump test the GX-2012. A parts list at the end of this appendix lists spare parts for the calibration kit.

Calibration/Bump Test Supplies and Equipment

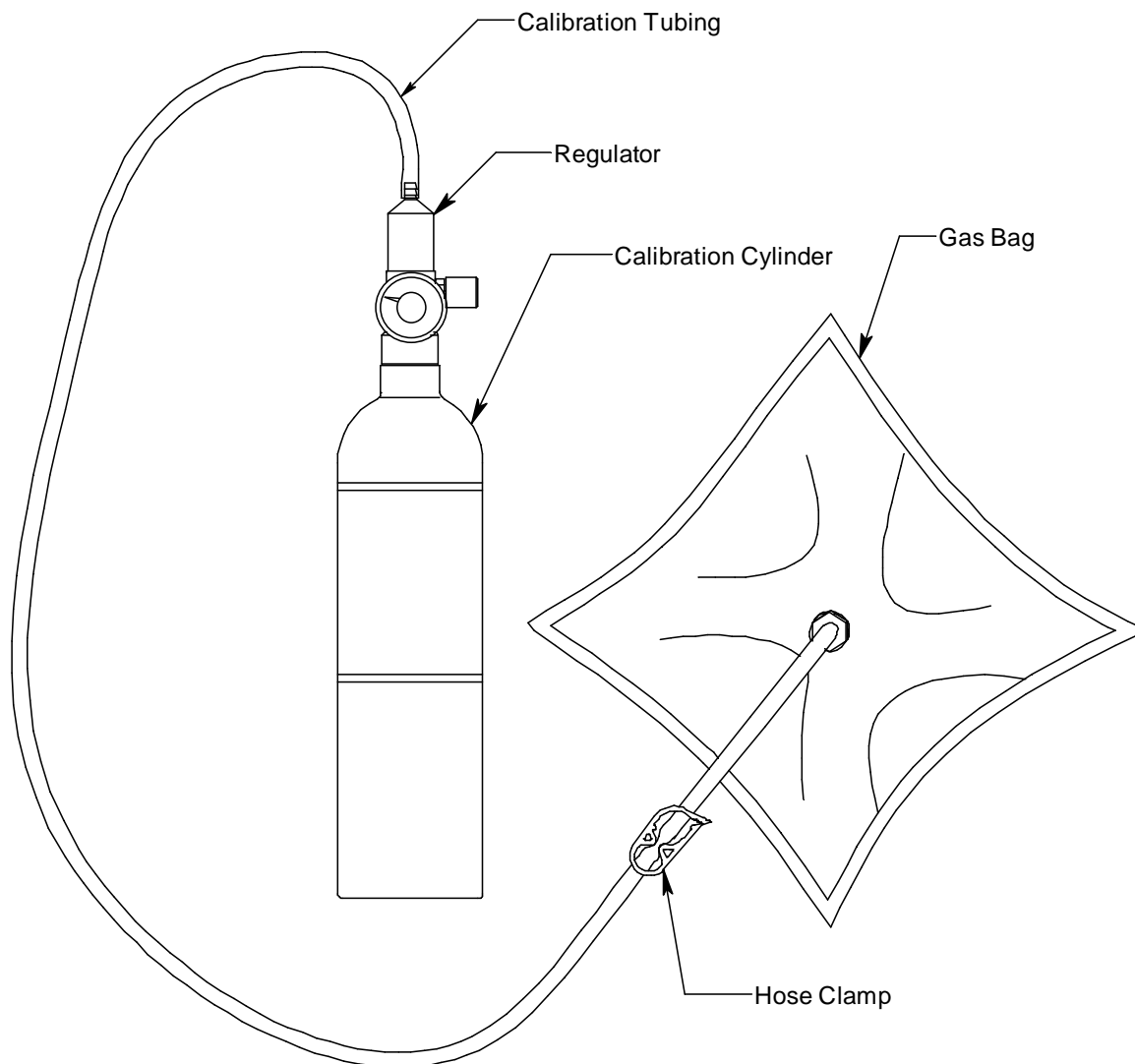

Figure 29: Gas Bag Calibration Kit

To calibrate or bump test the GX-2012, you will need:

- Known calibrating samples of the gases being detected. The combustible and toxic gas samples should have concentrations in approximately the middle of the range of detection. An oxygen-free source, such as 100% nitrogen is recommended for setting the oxygen zero when using single calibration.

WARNING: When using auto calibration, the multi-gas cylinder must have an oxygen concentration in the range of 10% - 18% oxygen.

- A gas collection bag with hose clamp
- A 0.5 LPM fixed-flow regulator or dispensing valve
- Non-absorbent tubing

To calibrate the %LEL, Oxygen, CO, and H₂S sensors at the same time, automatically, with no need for a zero-oxygen source, you can use the auto calibration feature with a 4-gas cylinder. If the H₂S channel is not active, then a 3-gas cylinder may be used for auto calibration. This appendix includes instructions for auto calibration with a fixed flow regulator or dispensing valve, a 4-gas cylinder, and a % volume methane cylinder. This document also includes instructions for calibrating one channel at a time using single calibration.

Preparing for Calibration or Bump Testing

Whether you will calibrate the GX-2012 using auto calibration or single calibration, or perform a bump test, you will need to set the fresh air readings first before setting the span readings for each gas.

1. Find a fresh-air environment. This is an environment free of toxic or combustible gases and of normal oxygen content (20.9%).
2. Turn on the unit as described in “Turning On the GX-2012, Normal Mode Only” on page 19 using the sample hose and probe.
3. With the unit on, perform a fresh air adjustment by pressing and holding the AIR▲ button. The display prompts you to hold the AIR▲ button.
4. Continue to hold the AIR▲ button until the display prompts you to release it. The GX-2012 will count down from 8 as it sets the fresh air reading for all channels. If the combustible channel is set as %LEL only or vol% only, there is no countdown period. The fresh air reading is set

immediately.

5. Slide the tubing clamp onto the tubing and connect the tubing onto the sample bag's inlet. Leave the clamp unclamped for now.
6. Connect the other end of the tubing to the regulator's or dispensing valve's hose barb fitting.
7. Fill the gas collection bag by screwing the fixed flow regulator onto the calibration cylinder or by screwing the dispensing valve onto the calibration cylinder and turning the knob counterclockwise.

NOTE: If the regulator has no on/off knob, then gas will begin to flow at 0.5 LPM as soon as the regulator is connected to the cylinder.

8. Allow the gas to dispense until the gas collection bag is a little over half full.
9. If a fixed flow regulator without a knob is used, disconnect it from the cylinder and immediately clamp down the hose clamp to prevent the release of gas from the gas collection bag.

If a fixed flow regulator with a knob or a dispensing valve is used, turn the knob clockwise to stop the gas flow, clamp down the hose clamp and remove the regulator or dispensing valve from the cylinder.

10. Disconnect the tubing from the regulator or dispensing valve.

Calibrating the GX-2012

From Measuring Mode, enter Calibration Mode by pressing and holding the (SHIFT)▼ button, then pressing the DISPLAY(ADJ) button and releasing both. If the unit prompts you for the password, enter it by using the AIR▲ and (SHIFT)▼ buttons to select each password number and then pressing and releasing POWER ENTER to confirm it and move on to the next number. The factory set password is the same as the factory set password for Maintenance Mode: 2102. You can change the password by entering the **PASSWORD** menu item in Maintenance Mode. See “Turning the Password Function On or Off” on page 120. If you enter an incorrect password, an error screen will display.

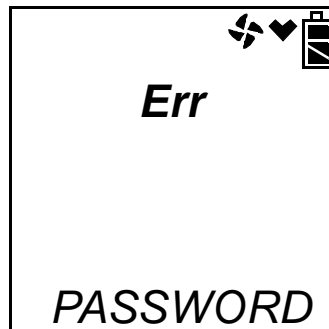

To return to normal operation, press and release the RESET SILENCE button. You may then try to reenter Calibration Mode.

MAINTENANCE will appear along the top of the screen once you have entered Calibration Mode. The first item in the calibration menu, AIR CAL, displays.

NOTE: The following screens illustrate a four-gas GX-2012 with both a % LEL and a % volume combustible sensor as examples only. Your GX-2012 may display slightly different screens.



The GX-2012's calibration menu includes two methods of calibration: auto calibration and single calibration.

- **Auto Calibration:** This method allows you to calibrate the combustible gas (%LEL sensor only), OXY, H₂S, and CO sensors simultaneously. It is designed for use with the RKI 4-gas calibration cylinder and is the quickest and easiest method to calibrate the GX-2012. If installed, you may also calibrate the % volume sensor separately from the standard four.
- **Single Calibration:** This method allows you to calibrate one sensor at a time. Use this method if you are only calibrating one or two sensors, if you are calibrating only the % volume combustible sensor, or if you are not using the RKI 4-gas calibration cylinder.

Calibrating with the Auto Calibration Method

This section describes calibration using the auto calibration method.

To calibrate using the single calibration method, see “Calibrating with the Single Calibration Method” on page 149. These instructions assume you are using a 4-gas cylinder and a % volume methane cylinder.

1. You may only calibrate either the standard 4 sensors or the % volume combustible gas sensor at a time. Once you are finished, you are returned to the initial AUTO CAL screen and must begin the auto calibration process again.
2. Use the AIR▲ and (SHIFT)▼ buttons to scroll to the **AUTO CAL** menu item. Press and release the POWER ENTER button to display the calibration values screen. If you want to exit back to the main menu without completing a calibration, press and release the DISPLAY (ADJ) button.

- Use the AIR▲ or (SHIFT)▼ button to alternate between the 4-gas and the % volume combustible gas calibration values screens.

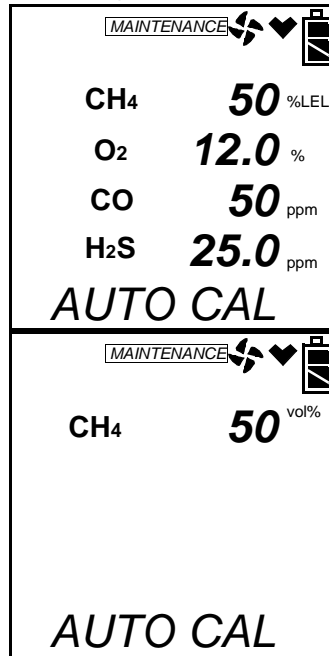

- The gas concentrations displayed in the calibration values screen must match the gas concentrations listed on the calibration cylinders. If *all* concentrations match, go to step 12. If *one or more* concentrations do not match, continue with step 5.
- To adjust the values on the screens, hold down the (SHIFT)▼ button, then press the DISPLAY(ADJ) button and release both. The %LEL sensor is shown.

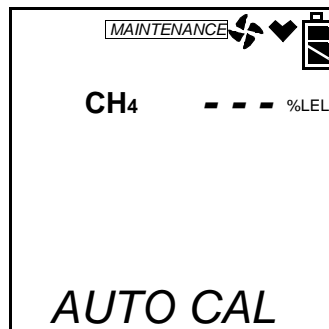

- Use the AIR▲ and (SHIFT)▼ buttons to scroll through the sensors and select the sensor whose calibration gas value you want to adjust.
- Press and release the POWER ENTER button. The sensor's calibration gas value will flash.
- If necessary, use the AIR▲ and (SHIFT)▼ buttons to set the correct calibration gas value.
- Press and release the POWER ENTER button to save the change.
- Repeat steps 6 through 9 to set the correct values for any additional

sensors.

11. After the last calibration gas value is set, use the AIR▲ button to scroll to ESCAPE and press POWER ENTER to return to the calibration gas values screens.

NOTE: The RKI Four Gas Cylinder typically contains 12% O₂ by volume. Be sure to set the “OXY” reading to agree with the concentration listed on the cylinder’s label, not zero.

12. Use the AIR▲ and (SHIFT)▼ button to select which sensor(s) you want to calibrate, the standard 4 sensors or the % volume combustible gas sensor.

The following instructions illustrate calibrating the standard 4 sensors first, then the % volume combustible gas sensor.

13. With the 4-gas calibration values screen displayed, press the POWER ENTER button. AUTO CAL begins to flash and the current gas readings are displayed. If you want to exit back to the main menu without completing a calibration, press and release the DISPLAY (ADJ) button.

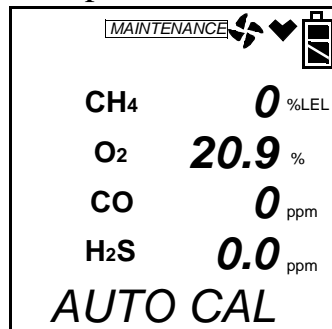

14. Open the hose clamp and connect the tubing from the filled gas bag to the rigid tube on the probe. Allow the gas to flow for one minute.
15. Press and release the POWER ENTER button to set the calibration to the programmed values.

If all channels passed calibration, PASS displays along the bottom of the screen, then the calibration menu displays.

If any of the sensors cannot calibrate to the proper value, FAIL displays along the bottom of the screen and the GX-2012 lists the sensor(s) that failed to calibrate. In the example below, the OXY and H₂S channels failed calibration. The other sensors calibrated normally.

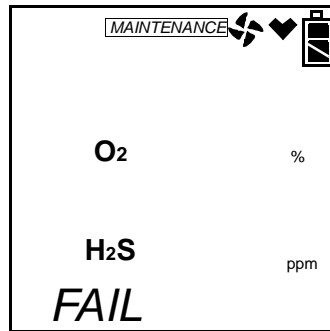

The buzzer and alarm lights activate. Press and release the RESET SILENCE button after the buzzer and lights stop to reset the alarm and return to the calibration menu. Attempt to calibrate again. If the failure continues, investigate the cause. See “Troubleshooting” on page 123.

16. Disconnect the tubing from the probe.
17. If you have a 5 sensor unit and wish to calibrate the % volume combustible gas sensor, go back to step 1 and repeat the process, selecting the % volume calibration gas value screen in step 12 and using a % volume methane cylinder to fill your gas bag.

If you are finished calibrating, use the (SHIFT)▼ button to navigate to the **NORMAL** menu item, then press and release the POWER ENTER button to return to Measuring Mode.

Calibrating with the Single Calibration Method

This section describes calibration using the Single Calibration method. To calibrate using the Auto Calibration method, see “Calibrating with the Auto Calibration Method” on page 145.

CAUTION: *The single calibration method does not have a “FAIL” notification. If a sensor cannot be set to agree with the calibration source, see “Troubleshooting” on page 123.*

1. While in the calibration menu, use the AIR▲ or (SHIFT)▼ button to the ONE CAL menu option.



2. Press and release the POWER ENTER button to display the single calibration menu. The %LEL sensor will be displayed first.

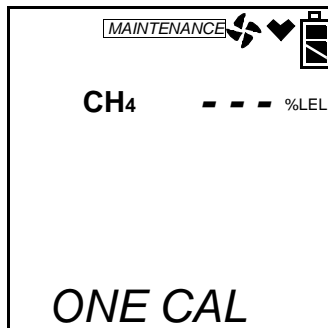

3. Use the AIR▲ or (SHIFT)▼ button to display the sensor you want to calibrate (in this example the combustible gas % LEL sensor). If you have a 5 sensor unit, the %vol sensor will be one of the choices. It is shown below.

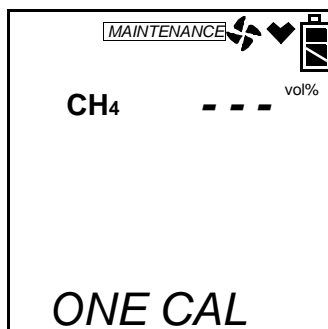

4. Press and release the POWER ENTER button. The single calibration screen displays for the sensor you selected. The gas reading flashes.

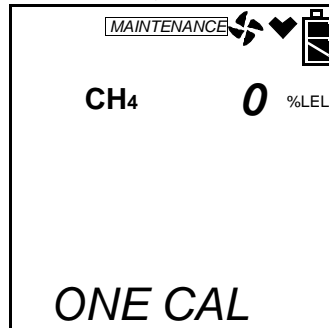

5. Connect the tubing from the filled gas bag to the rigid tube on the probe. Allow the calibration gas to flow for one minute.
6. If necessary, use the AIR▲ and (SHIFT)▼ buttons to adjust the reading to match the concentration listed on the calibration cylinder.
7. Press and release the POWER ENTER button to save the span value. The LCD will indicate that the calibration has ended, then the single calibration menu displays.

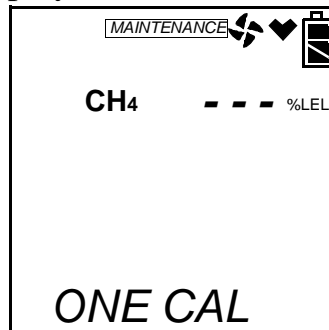

8. Disconnect the tubing from the GX-2012's probe.
9. Repeat steps 3 through 8 for any other sensors you want to calibrate. Make sure you use an appropriate calibration cylinder for each sensor.

CAUTION: When calibrating the oxygen channel, verify the concentration of oxygen listed on the cylinder's label. For oxygen-free samples (100% nitrogen for example), set the oxygen zero setting to 0.0%.

10. After the last channel is calibrated, disconnect the calibration tubing from the probe.
11. Use the AIR▲ and (SHIFT)▼ buttons to scroll to ESCAPE in the ONE CAL menu.
12. Press and release the POWER ENTER button to exit ONE CAL.
13. With the ONE CAL menu option displayed, press the (SHIFT)▼ button until the **NORMAL** menu option is displayed.

14. Press and release the POWER ENTER button to return to Measuring Mode.

Bump Testing

NOTE: The **BUMP DSP** menu item in Maintenance Mode is factory set to OFF. The **BUMP** menu item will not appear unless **BUMP DSP** is set to ON. See “Turning the Bump Test Function On or Off” on page 106 for instructions.

NOTE: The GX-2012 uses parameters defined in the **BUMP--SET** menu item of Maintenance Mode while performing a bump test. To view or update these parameters, see “Updating the Bump Test Parameters” on page 108.

From Measuring Mode, enter Calibration Mode by pressing and holding the (SHIFT)▼ button, then pressing the DISPLAY(ADJ) button and releasing both. If the unit prompts you for the password, enter it by using the AIR▲ and (SHIFT)▼ buttons to select each password number and then pressing and releasing POWER ENTER to confirm it and move on to the next number. The factory set password is the same as the factory set password for Maintenance Mode: 2102. You can change the password by entering the **PASSWORD** menu item in Maintenance Mode. See “Turning the Password Function On or Off” on page 120. If you enter an incorrect password, an error screen will display.

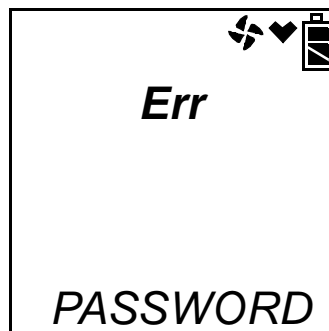

To return to normal operation, press and release the RESET SILENCE button. You may then try to reenter Calibration Mode.

MAINTENANCE will appear along the top of the screen once you have entered Calibration Mode. The first item in the calibration menu, AIR CAL, displays.

1. Slide the tubing clamp onto the tubing and connect the tubing onto the sample bag’s inlet. Leave the clamp unclamped for now.
2. Connect the other end of the tubing to the regulator’s or dispensing valve’s hose barb fitting.

3. Fill the gas collection bag by screwing the fixed flow regulator onto the calibration cylinder or by screwing the dispensing valve onto the calibration cylinder and turning the knob counterclockwise.

NOTE: If the regulator has no on/off knob, then gas will begin to flow at 0.5 LPM as soon as the regulator is connected to the cylinder.

4. Allow the gas to dispense until the gas collection bag is a little over half full.
5. If a fixed flow regulator without a knob is used, disconnect it from the cylinder and immediately clamp down the hose clamp to prevent the release of gas from the gas collection bag. If a fixed flow regulator with a knob or a dispensing valve is used, turn the knob clockwise to stop the gas flow, clamp down the hose clamp and remove the regulator or dispensing valve from the cylinder.
6. Disconnect the tubing from the regulator or dispensing valve.
7. Install the hose and probe to the GX-2012.
8. Use the AIR▲ or (SHIFT)▼ buttons to display the BUMP menu item.

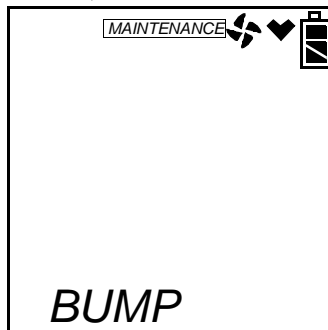

9. Press and release the POWER ENTER button to display the bump test gas values.

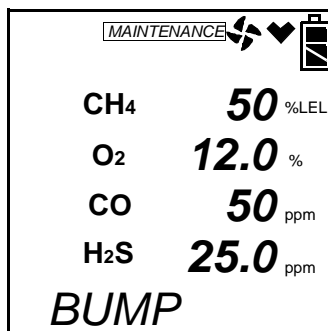

10. Use the AIR▲ or (SHIFT)▼ buttons to see the %volume combustible gas bump test value.

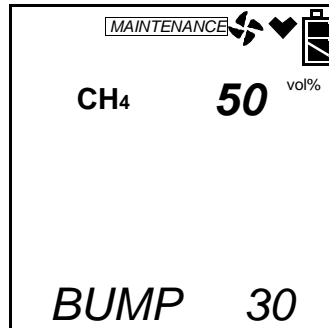

11. A bump test may be performed on the standard 4 sensors or on the %volume combustible sensor. Use the AIR▲ or (SHIFT)▼ buttons to display the screen for the sensor(s) you wish to bump test.
12. Before proceeding, confirm that the bump test gas value(s) are the same as the concentration(s) in the calibration cylinder. If they are not, adjust the bump test gas value(s) by entering the AUTO CAL menu item, changing the values there, and reentering the BUMP menu.
13. Open the hose clamp and connect the tubing from the filled gas bag to the rigid tube on the probe and quickly press and release the POWER ENTER button. The unit will begin counting down from 30.
14. When AUTO CAL in the **BUMP--SET** menu item in Maintenance Mode is set to OFF:
- The instrument will indicate which channels passed or failed the bump test with a P (pass) or an F (fail) to the right of the gas.

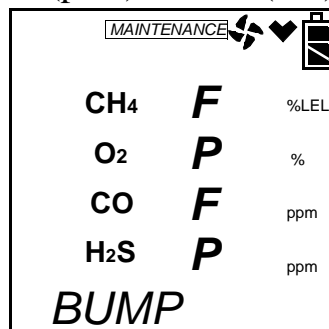

- To view the bump test gas readings press the AIR▲ or (SHIFT)▼ button. You can scroll between the bump test results and the bump test gas readings with the AIR▲ or (SHIFT)▼ buttons.

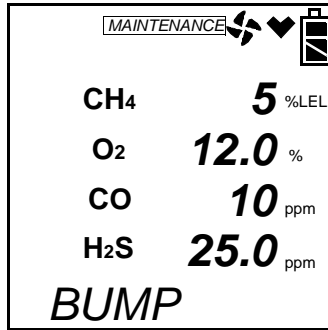

- To return to the BUMP screen in Calibration Mode, press POWER ENTER.

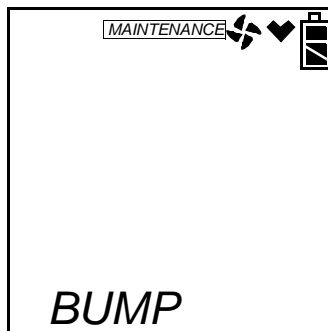

If one or more sensors fail the bump test, see “Troubleshooting” on page 123 to investigate the cause of the failure and replace the failed sensor or sensors if necessary.

- Disconnect the tubing from the probe.

15. When AUTO CAL in the **BUMP--SET** menu item in Maintenance Mode is set to ON:

If all channels pass the bump test,

- The following screen appears:

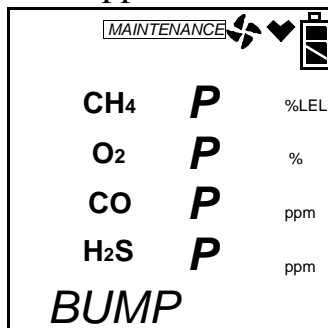

- To view the bump test gas readings press the AIR▲ or (SHIFT)▼ button. You can scroll between the bump test results and the bump test gas readings with the AIR▲ or (SHIFT)▼ buttons.

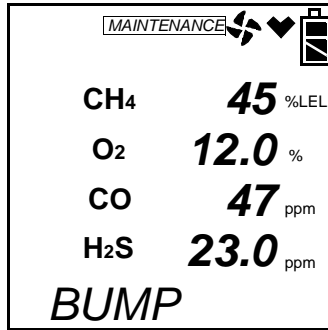

- To return to the BUMP screen in Calibration Mode, press POWER ENTER.

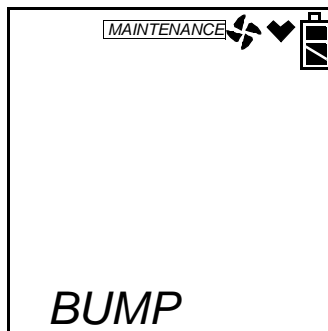

- Disconnect the tubing from the probe.

If any channel fails the bump test,

- The instrument will beep and a calibration is immediately and automatically started. Continue to apply the calibration gas. CAL on the bottom left of the screen will alternate with APPLY.

The calibration time will begin to countdown in seconds in the lower right of the screen. The calibration time counted down during a calibration initiated because of a failed bump test is the difference between the bump test gas time and the calibration time defined in the **BUMP--SET** menu item in Maintenance Mode.

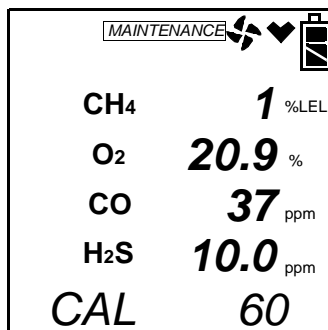

- At the end of the calibration, the instrument displays the results from both the bump test and the calibration. Use the AIR▲ or (SHIFT)▼

buttons to scroll between the calibration/bump test results, the bump test gas readings, and the calibration gas readings.

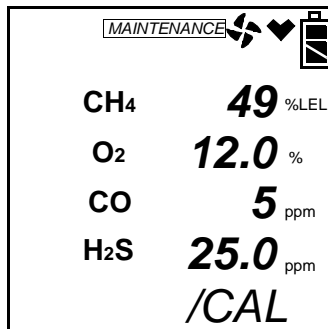
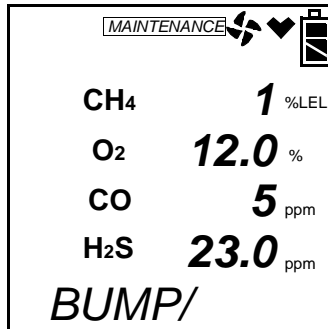
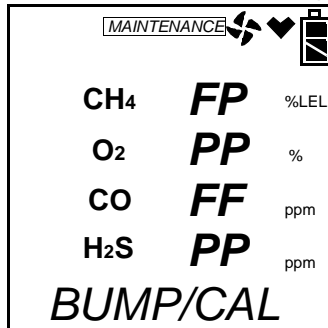

- To return to the BUMP screen in Calibration Mode, press POWER ENTER at any time. If any channel failed the calibration, the buzzer will sound a double pulsing tone until you press and release the POWER ENTER button.

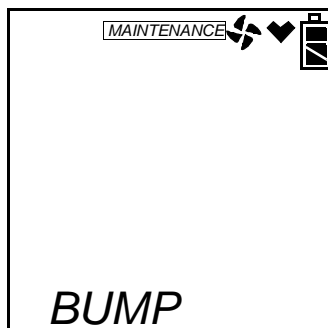

- Disconnect the tubing from the probe.

16. With the BUMP menu option displayed, press the (SHIFT)▼ button until the **NORMAL** menu option is displayed.
17. Press and release the POWER ENTER button to return to Measuring Mode.

Parts List

Table 10: Sample Bag Calibration Kit Spare Parts

Part Number	Description
81-0016RK-05	Calibration cylinder, 100% volume methane in nitrogen, 58 liter
81-0090RK-01	Calibration cylinder, 3-gas mix, LEL/Oxygen/CO, 34 liter
81-0154RK-04	Calibration cylinder, 4-gas mix, LEL/Oxygen/CO/H ₂ S, 34 liter
81-1001RK	Dispensing valve, for 17/34 liter cylinders
81-1051RK	Regulator with gauge and knob, 34AL/58 liter/103 liter cylinders, 0.5 LPM
81-1126RK	Gas bag with clamp and hose barb, 9" x 9", 2 liter